

Burst-Mode Receiver for 50G-EPON Optical Line Terminals

Naruto TANAKA*, Daisuke UMEDA, Yoshiyuki SUGIMOTO, Tomoyuki FUNADA, Keiji TANAKA, and Shoichi OGITA

A large capacity of the Internet is strongly demanded due to the increase of internet-connected devices and the diversification of internet-based services. To address these needs, we are in a new phase to upgrade the transmission speed of access optical networks from the current mainstream 10G class to 50G class. We have developed a new transimpedance amplifier (TIA) capable of receiving 25.78 Gbit/s burst signals to meet the demand for higher-speed transmission. Using the TIA and avalanche photodiode (APD), we have developed a 25.78 Gbit/s/λ burst-mode receiver, and confirmed its applicability to 50G-EPON optical transceivers for the first time in the world.

Keywords: optical receiver, TIA, burst, 50G

1. Introduction

Passive optical network (PON) systems have widely spread throughout the world as a means of realizing low-cost fiber-to-the-home (FTTH) services. Sumitomo Electric Industries, Ltd. has contributed to the progress of optical communication technology through the development of various sorts of optical components and systems.⁽¹⁾⁻⁽³⁾ Recently, the demand for higher transmission speed of access communication is rapidly increasing as using large-capacity contents, such as 4K/8K video transmission, is spreading. As a next-generation PON system having a communication speed of more than 10 Gbit/s, ITU-T has already completed the standardization of NG-PON2⁽⁴⁾, which is capable of transmitting 40 Gbit/s signals. The NG-PON2 standard uses the time and wavelength division multiplexing (TWDM) system. Thus, all the physical media dependent (PMD)*¹ sublayer components such as a laser diode (LD), an avalanche photodiode (APD), a LD driver, and a transimpedance amplifier (TIA) are still in the 10 Gbit/s grade in this system.

As a higher-speed PON system, Institute of Electrical and Electronics Engineers (IEEE) established a task force in 2016 to standardize 50 Gbit/s Ethernet PON (50G-EPON)⁽⁵⁾ and completed the approval in June 2020. We actively participated in this standardization process and contributed to settle the PMD specifications. Since 50G-EPON is realized by a TWDM system that uses two wavelengths, a transmission rate of 25.78 Gbit/s per wavelength is required.

Recently, we have developed a 25.78 Gbit/s burst-mode receiver, a key PMD component for a 50G-EPON optical line terminal (OLT).

2. 50G-EPON Upstream Transmission

2-1 System overviews and required conditions

Figure 1 shows an outline of the 50G-EPON system configuration and upstream transmission. As discussed above, 50G-EPON is realized by a TWDM system that transmits two wavelengths at a rate of 25.78 Gbit/s. The 50G-EPON system is required to support a maximum

channel insertion loss of 29 dB to use existing optical access networks and is also designed so that it can be deployed in the same optical access network with a 10G-EPON⁽⁶⁾ system to achieve a smooth migration from conventional 10G-EPON to 50G-EPON. Thus, 25G and 10G time division multiplexed signals (burst signals) coexist on the same wavelength in some migration cases. Therefore, the 50G-EPON OLT is required to receive 25G and 10G burst signals at the same time. Accordingly, the PMD components used in 50G-EPON are also required to comply with the 10G-EPON standard.

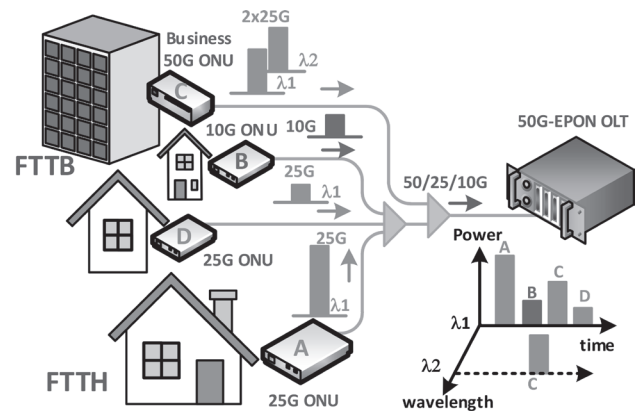

Fig. 1. 50G-EPON system overview and upstream transmission

2-2 Requirements

Table 1 shows the standard specifications relating to the receiver characteristics of 50G-EPON OLT. Power budget classes (PQ30 and PQ20) are defined according to each channel insertion loss to be supported. For 25.78 Gbit/s signal transmission per wavelength in the upstream direction, the specifications for the input power differ between the above two classes. To support both power classes with a single device, we set the input power specifications shown in bold in Table 1 as the specifications required of the burst-mode receiver. The specifications show that the

receiver needs to respond to a large burst input power ratio from the minimum receiver sensitivity to overload, which is the burst dynamic range, within a short settling time.

Table 1. Standard specifications for OLT receiver

Parameters	PQ30	PQ20	PQ30	PR30	Unit
Line rate	25.78125		10.3125		GBd
Wavelength†	1270,1300		1270		nm
Max. Channel Insertion Loss	29	24	29		dB
Min. Channel Insertion Loss	15	10	15		dB
Bit Error Ratio	10 ⁻²	10 ⁻²	10 ⁻²	10 ⁻³	-
Overload	-6	-3	-6		dBm
Min. Receiver Sensitivity‡	-24.3	-22.7	-28		dBm
Settling Time	800				ns

†: An example when wavelength coexists with GPON system

‡: PQ30 and PQ20 are defined in terms of optical modulation amplitude (OMA)

3. Optical Receiver for 50G-EPON OLT

3-1 Optical receiver

Photo 1 shows the external view of burst-mode optical receiver that uses conventional coaxial packaging technologies. Its coaxial diameter of 3.15 mm is small enough to be implemented in transceivers with the general form factor like small form-factor pluggable 28 (SFP28)*². It is also suitable to be integrated to a bi-directional optical sub-assembly with an optical transmitter. This receiver consists of a receptacle that is connected with an optical fiber, a flexible printed circuit (FPC) board that is connected with a printed circuit board of an optical transceiver, APD, and a package in which a burst-mode TIA (BM-TIA) is hermetically sealed. The APD is flip-chip mounted*³ on the carrier, and bonding wires connect the carrier, BM-TIA, and package.



Photo 1. Burst-Mode receiver for 50G-EPON OLT

3-2 Design of BM-TIA IC

Figure 2 shows the block diagram of the BM-TIA that we have newly developed to meet the above requirements. This BM-TIA (a) reduces noise by a shunt-feedback-type TIA having high feedback resistance, (b) widens the burst dynamic range by a high-speed automatic offset gain control (AOGC) function, and (c) enables fast burst responses by an autonomous control function that isn't supported by any external control signal.⁽⁷⁾

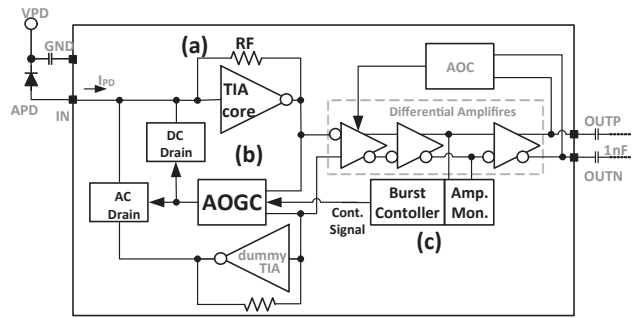

Fig. 2. Block diagram of 25.78 Gbit/s BM-TIA

Photo 2 shows a photo of the BM-TIA chip. The chip, whose dimensions are 1.56 × 0.71 mm, was fabricated by the 0.13-um SiGe: C-BiCMOS (ft/fmax = 300/500 GHz) process.

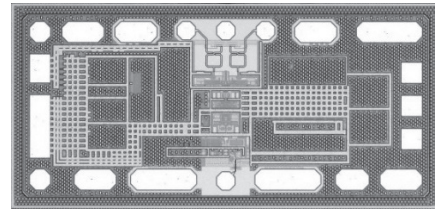

Photo 2. A photo of BM-TIA IC chip

4. Characteristics of Burst-Mode Receiver

4-1 Frequency responses

Figure 3 shows the high-frequency response of optoelectronic trans-impedance ($Z_{T(O-E)}$) and evaluation board loss, both of which were normalized by low-frequency signal strength. The 3 dB bandwidth of $Z_{T(O-E)}$ is 11.8 GHz. The 3dB bandwidth of the APD is around 10 GHz when its multiplication factor is 6 as reported in (8). Therefore, the additional peaking function in BM-TIA was activated to overcome APD's bandwidth limitation for 25.78 Gbit/s signal reception.

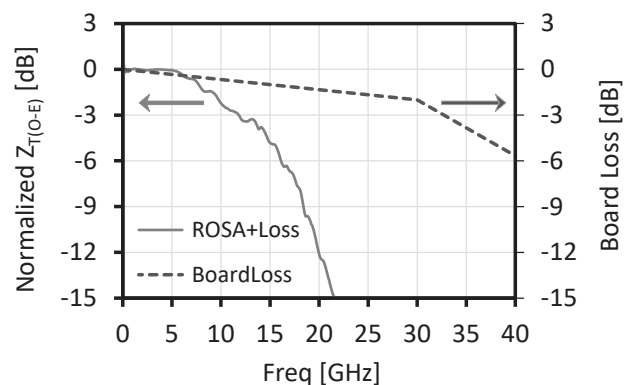

Fig. 3. High-frequency response of optoelectronic conversion gain ($Z_{T(O-E)}$)

The 3 dB bandwidth after removing the evaluation board loss is approximately 14 GHz, which is sufficient for a 25.78 Gbit/s operation.

The dependence of low cutoff frequency and normalized $Z_{T(O-E)}$ on the optical input power is shown in Fig. 4. The gain is controlled in inverse proportion to the input power in its range of -10 dBm and more, demonstrating that the input power range can be expanded successfully. When receiving 10.31 Gbit/s random signals containing low-frequency components, it is desirable that the low cutoff frequency is low. However, the response speed to burst signals decreases. In a middle to strong input power range of -15 dBm and more, the low cutoff frequency is stably controlled to around approximately 2 MHz, verifying that the newly developed burst-mode optical receiver ensures both the fast burst response and stable 10 Gbit/s reception.

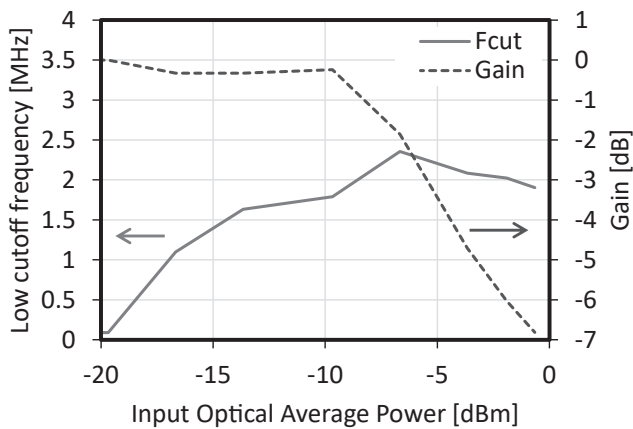

Fig. 4. Dependence of low-pass cutoff frequency $Z_{T(O-E)}$ on optical input power

4-2 Optical receiver characteristics

Figure 5 shows the eye diagrams of 25.78 Gbit/s Pseudo-Random Binary Sequence (PRBS) $2^{31}-1$ signal, of which (a) represents an input optical signal and (b), (c), and (d) represent the single-ended output electrical signals at each input power. From these figures, we confirmed that,

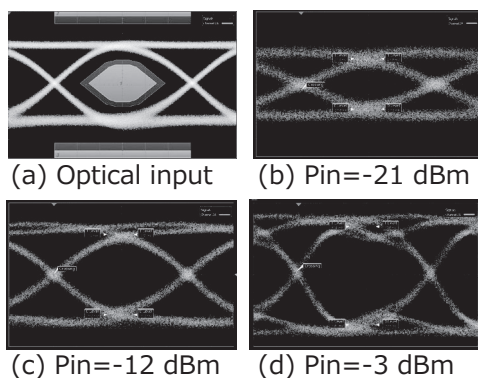

Fig. 5. 25.78 Gbit/s optical input and electrical output waveforms

in an input range of -21 to -3 dBm, our newly developed burst-mode optical receiver exhibits enough eye openings without pattern-dependent jitter.

Figure 6 shows an example of the input optical signal used to measure bit error ratio (BER) during burst signal reception. BER was measured in the payload section within the weak input burst signal, which was placed immediately after the strong input burst signal.

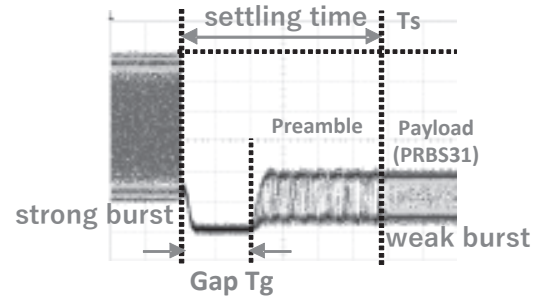

Fig. 6. Input optical signals for bit error ratio measurement

Fixed preamble patterns for synchronization are repeated at the beginning of the weak input burst signal, and the section from the trailing end of the strong input burst signal to the start of the payload is defined as the settling time (T_s). For 10G-EPON and 50G-EPON, the T_s is specified to be 800 ns at the maximum. In practice, we set the strong input burst signal to -3 dBm, the maximum input power specified in the standard, T_s to 600 ns, the inter-burst gap, T_g to 0 ns, and the payload pattern to PRBS $2^{31}-1$.

The BERs measured in case of 25.78 Gbit/s signal reception are shown in Fig. 7. T_s was set to 600 ns, which was faster than the PQ30 standard specification. However,

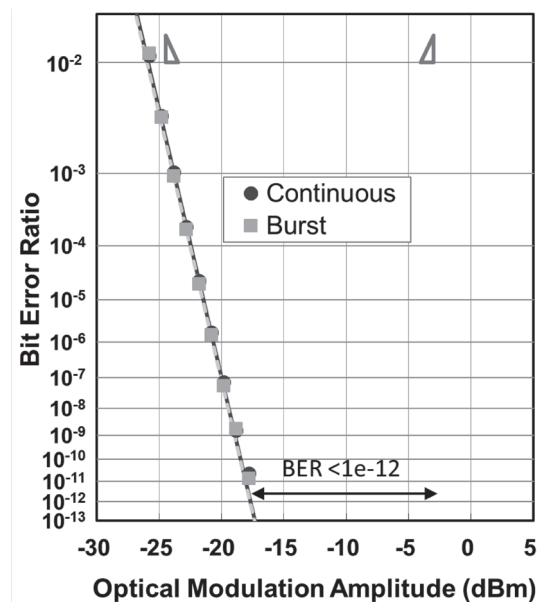

Fig. 7. 25.78 Gbit/s Bit Error Ratio results

there was substantially no difference in BER between continuous and burst signals, verifying that this newly developed burst-mode optical receiver enables sufficiently fast burst responses. In addition, the minimum optical modulation amplitude (OMA) sensitivity at BER=10⁻² was -26 dBm, fully satisfying the minimum sensitivity specification of the 50G-EPON high-power class with at least 1.7dB margin. Further, BER was 10⁻¹² or less at input power ranging from -18 to -3 dBm (OMA), verifying that this receiver also has sufficient maximum input power tolerance PQ20 standard specification. Conclusively, the newly developed burst-mode optical receiver has a maximum burst dynamic range of 23 dB or more.

Figure 8 shows the BERs that were measured during 10.31 Gbit/s PRBS2³¹-1 signal reception. Similarly to the case of 25.78 Gbit/s signal reception, there is no large difference in BER between continuous and burst signals, verifying that the new optical receiver enables fast burst response. Also, the minimum receiver sensitivities at BER = 10⁻³ and 10⁻² were -30.3 dBm and -32 dBm, respectively, fully satisfying the requirements of the PR30 and PQ30 standards. In addition, BER was 10⁻¹² or less over the entire input strength range of -24 to -6 dBm, satisfying the standard for maximum input power tolerance against PR30 and PQ30. Accordingly, the maximum burst dynamic range is 26 dB or more.

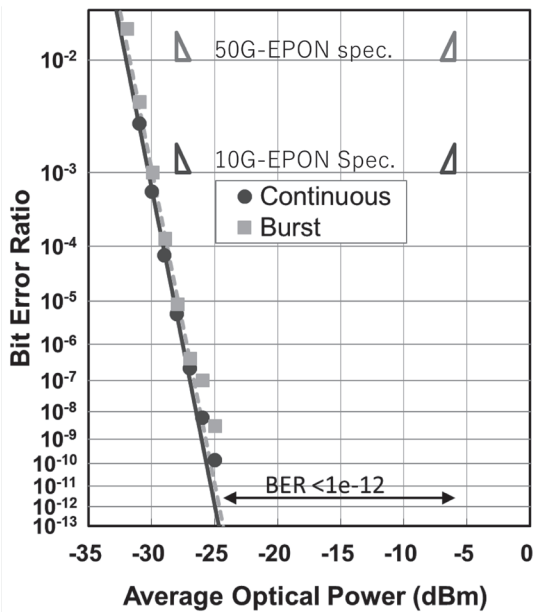

Fig. 8. 10.31 Gbit/s Bit Error Ratio results

5. Conclusion

We have developed a 25.78 Gbit/s burst-mode receiver fully applicable to a 50G-EPON OLT and tested its 25G/10G dual-rate signal reception performance. The test results verified that the newly developed burst-mode receiver satisfies the receiver sensitivity specified for all the classes of 50G-EPON and 10G-EPON with sufficient

margins. This burst-mode receiver can offer a flexible next-generation PON system by supporting 50G-EPON and 10G-EPON dual rate operation.

• Ethernet is a trademark of XEROX Corporation

Technical Terms

- *1 physical-media-dependent (PMD): PMD is defined as the lowest sublayer in the physical layer, the first layer of an OSI reference model that specifies the hierarchical structure of a communication function.
- *2 small form-factor pluggable 28 (SFP28): An industry standard transceiver for 25 Gbit/s signal transmission.
- *3 Flip-chip mounting: A method of mounting PD on its carrier. Instead of mounting PD with wires, metal terminals on PD's surfaces are directly bonded to its carrier.

References

- (1) M. Yoshimura, "Optical Transceiver Devices for GE-PON FTTH System," Journal of Japan Institute of Electrical Packaging, Vol. 12 No. 5 (Aug. 2009)
- (2) T. Funada, "Development of Small Optical Transceiver for 10G-EPON," SEI Technical Review, No. 75 (Oct. 2012)
- (3) Y. Kai, "10G-EPON System Featuring High-Speed and High-Capacity Layer 3 Switching," SEI Technical Review, No.83 (Oct. 2016)
- (4) ITU-T G.989.1, 40 Gigabit-capable passive optical networks (NGPON2): General requirements (2013)
- (5) IEEE 802.3ca, "Physical Layer Specifications and Management Parameters for 25 Gb/s and 50 Gb/s Passive Optical Networks," D2.0 (2019)
- (6) IEEE 802.3, "Physical Layer Specifications and Management Parameters for 10 Gb/s Passive Optical Networks" (2009)
- (7) K. Tanaka et al, "25.78-Gbit/s Burst Mode TIA for 50G-EPON OLT," BCICTS 2019 277-FM854
- (8) T. Endo et al, "Highly reliable grown-junction InP/InGaAs avalanche photodiodes for high-speed integrated optical receivers," IPRM 2018, paper Fr3A9-6 (2018)

Contributors The lead author is indicated by an asterisk (*).

N. TANAKA*

• Assistant Manager, Transmission Devices Laboratory

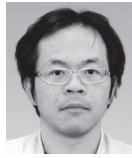

D. UMEDA

• Group Manager, Information Network R&D Center

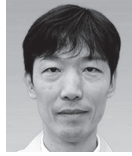

Y. SUGIMOTO

• Assistant General Manager, Transmission Devices Laboratory

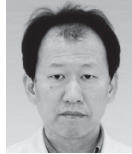

T. FUNADA

• Group Manager, Information Network R&D Center



K. TANAKA

• Group Manager, Transmission Devices Laboratory



S. OGITA

• Ph. D of Engineering
Chief Engineer, Transmission Devices Laboratory

