

R & D

Research & Development

Each company of the "Sumitomo Electric Group" combines its unsurpassed creativity with knowledge and experience to generate ideas that allows the group to contribute to society.

Sumitomo Electric Industries, Ltd.

• Osaka Works

1-1-3, Shimaya, Konohana-ku, Osaka 554-0024, Japan
Tel: +81 6 6466 5651 Fax: +81 6 6463 7229

Cyber-security R&D Office, CAS-EV Development Promotion Office, Advanced Automotive Systems R&D Center, Power Systems R&D Center, Information Network R&D Center, IoT R&D Center, Analysis Technology Research Center, Frontier Technologies Laboratory, Energy and Electronics Materials Laboratory, Transmission Devices Laboratory, Power Device Development Division, R&D Planning & Administration Division

• Itami Works

1-1-1, Koyakita, Itami, Hyogo 664-0016, Japan
Tel: +81 72 772 3300 Fax: +81 72 772 2525

Analysis Technology Research Center, Advanced Materials Laboratory, Transmission Devices Laboratory, Power Device Development Division, R&D Planning & Administration Division, Energy and Electronics Materials Laboratory

• Head Office (Osaka)

5-33, Kitahama 4-chome, Chuo-ku, Osaka 541-0041, Japan
Tel: +81 6 6220 4141

• Yokohama Works

1, Taya-cho, Sakae-ku, Yokohama 244-8588, Japan
Tel: +81 45 853 7182 Fax: +81 45 852 0597

Analysis Technology Research Center, Optical Communications Laboratory, Transmission Devices Laboratory, R&D Planning & Administration Division

Advanced Automotive Systems R&D Center, Power Systems R&D Center, Information Network R&D Center, Frontier Technologies Laboratory

• Head Office (Tokyo)

Akasaka Center Building
1-3-13, Motoakasaka, Minato-ku, Tokyo 107-8468, Japan
Tel: +81 3 6406 2600

R&D Planning & Administration Division

<https://global-sei.com/>

R&D Organization

Mid-Term Management Plan VISION 2022 and R&D Activities

Along with various changes such as the evolutionary change of automobiles, widespread use of renewable energy, and big data usage, new social needs have emerged. Sumitomo Electric aims to grow its business in the fields of mobility, energy, and communications as well as develop products and solutions supporting these fields. Leveraging the diversity of its business and technology, the company hopes to create innovations and contribute to the realization of a better society.

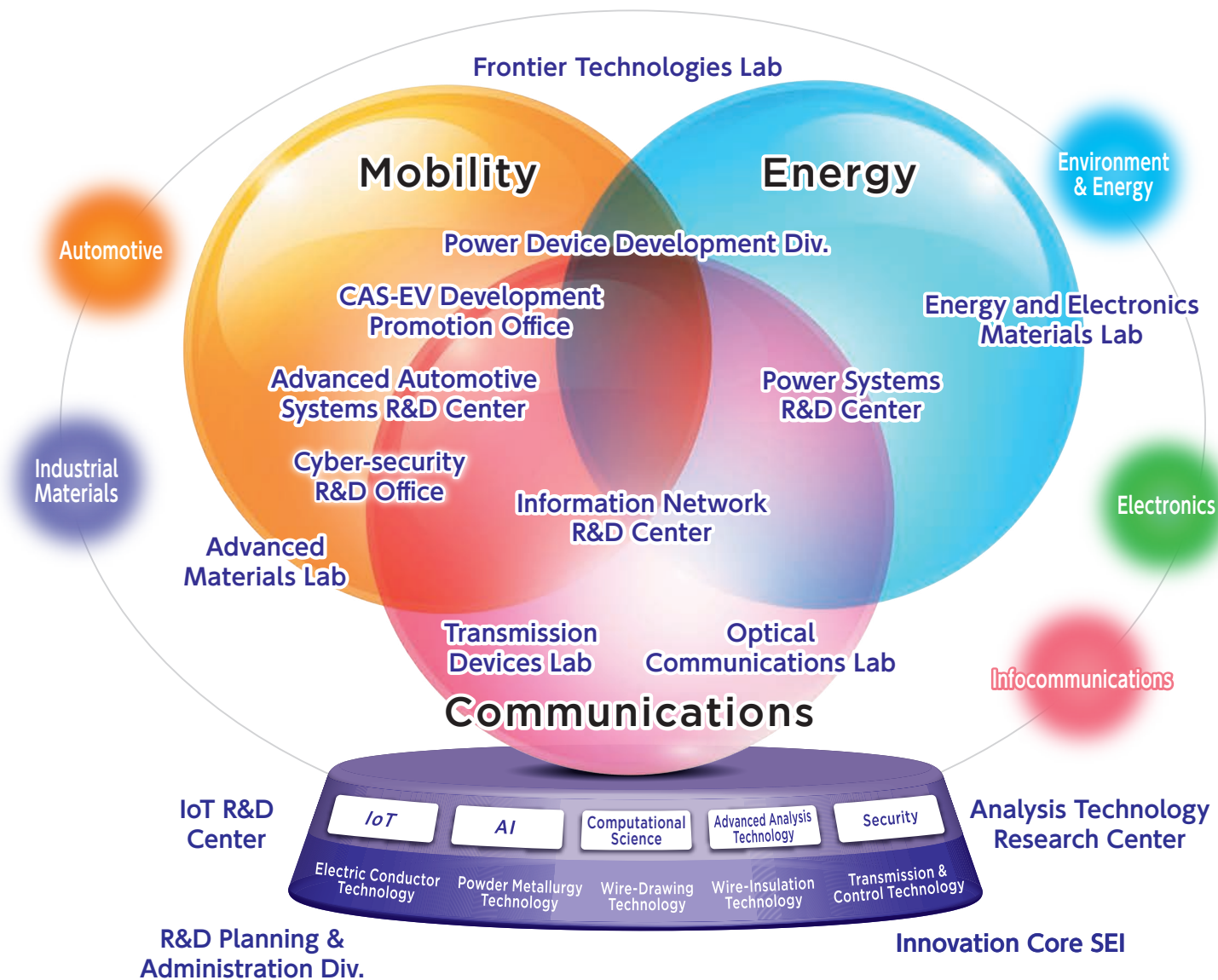

Overseas Operations

Innovation Core SEI, Inc. (ICS)

2355 Zanker Road, San Jose, CA 95131, U.S.A
TEL : +1-408-232-9511



San Jose office

ICS was established in Silicon Valley in the U.S. as our first overseas R&D base. By using cutting edge information concentrated in the area, ICS is working on research for next generation technologies and markets in the automotive, environment & energy, and infocommunications fields, as well as on new business development in integrated fields. Besides conducting R&D projects with our domestic laboratories and R&D centers, ICS is also focusing on open innovation for R&D globalization and promoting global internship programs.

Automotive

- Research connected car and autonomous driving technologies and participate in pilot projects
- Research and develop infrastructure for next generation energy efficient vehicles including electric vehicles (EVs)
- Research and analyze trends in fast-changing future mobility



Environment & Energy

- Commercialize redox flow batteries and concentrator photovoltaic systems as the core products of our future energy business
- Develop new businesses in the integrated field of electric power and infocommunications
- Explore applications for our material technologies in the environment & energy field



Redox flow battery introduced in US

Infocommunications

- Research trends in the technological evolution of cloud networks
- Propose new technologies to support advanced communications
- Create new businesses in the Internet of Things (IoT) and Industry 4.0 fields

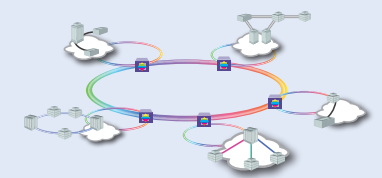

China Analysis Technology Center

No.232 Jinfeng Road, SND, Suzhou, Jiangsu, China
TEL: +86-512-6665-3090



The China Analysis Technology Center is located in the Sumitomo Electric Interconnect Products (Suzhou) Ltd. (SESZ) building.

The China Analysis Technology Center is located in Suzhou, east China, and provides analytical support for the production and development of our group in China.

CAS-EV Development Promotion Office

CAS-EV, the acronym for "Connected, Autonomous, Shared & Service, EV," represents a revolutionary automotive field

As a technical one-stop desk, we offer optimum system solutions in response to changes in fields where vehicles are connected with traffic communication and energy infrastructure. We also promote the development of vehicle components matching customers' needs with the Group's expertise and resources.

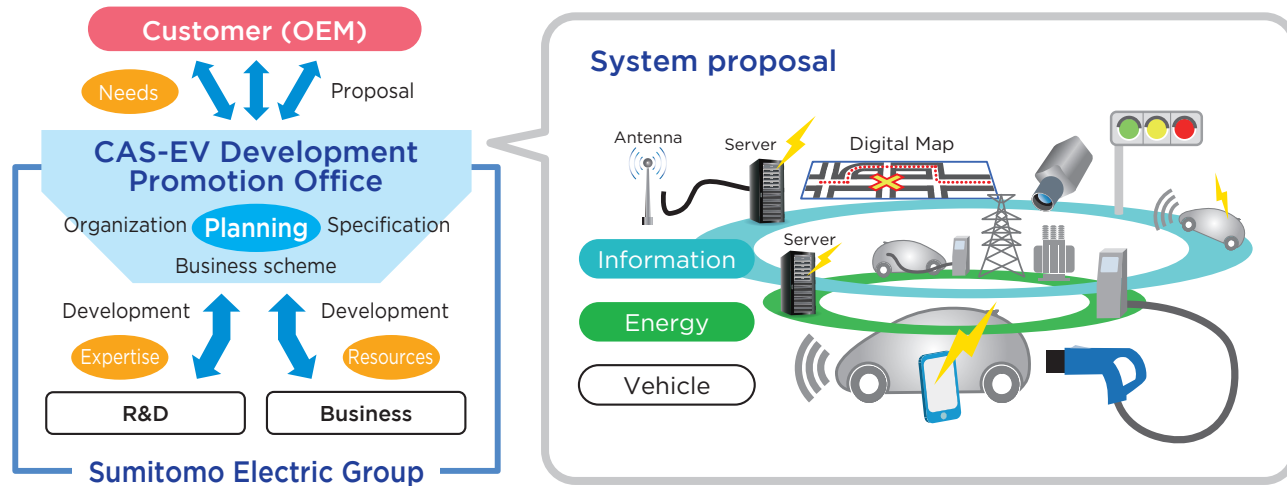

Advanced Automotive Systems R&D Center

We are developing electric vehicle technologies and connected technologies for next generation vehicles utilizing our expertise in the material and infocommunications fields to contribute to our automotive business.

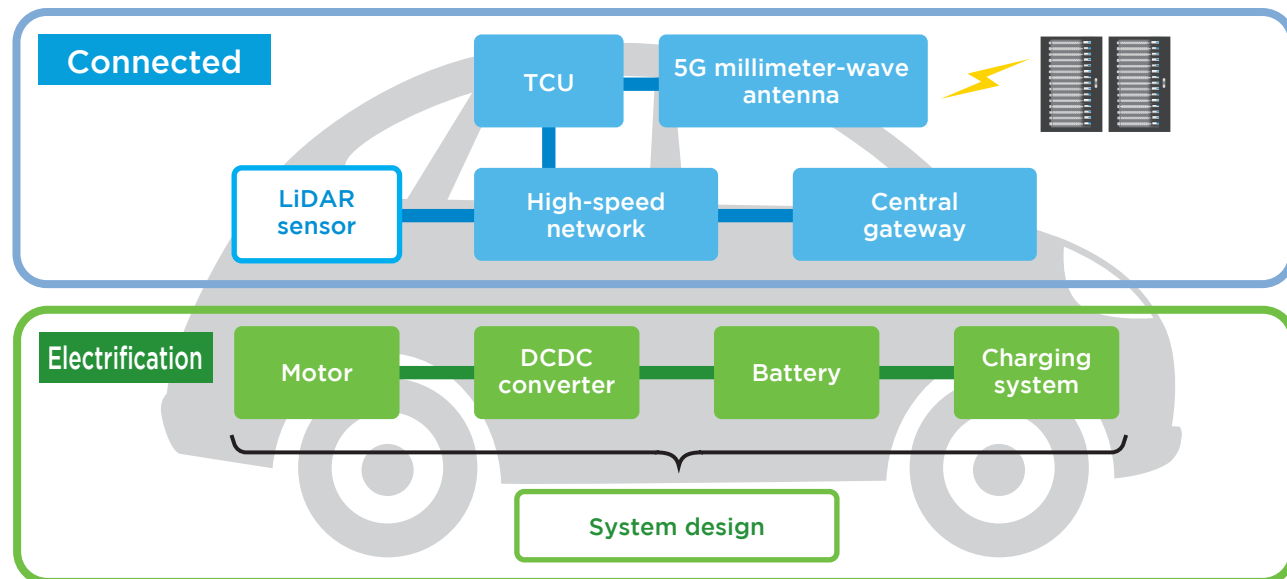

Cyber-physical design

Utilizing vehicle simulation and actual vehicle evaluation at the Yokohama test bed, we identify what makes vehicles and driving enjoyable from a manufacturer or user's point of view, and contribute to "concept-in" development with our customers.

Connected vehicle

We are conducting R&D in vehicle-to-vehicle/road-to-vehicle communication and high speed in-vehicle networks including related security measures for a future society where autonomous driving, driver assistance and connected cars using advanced information systems will be widespread. We are also working on the development of parts and materials for higher frequency wireless communication.

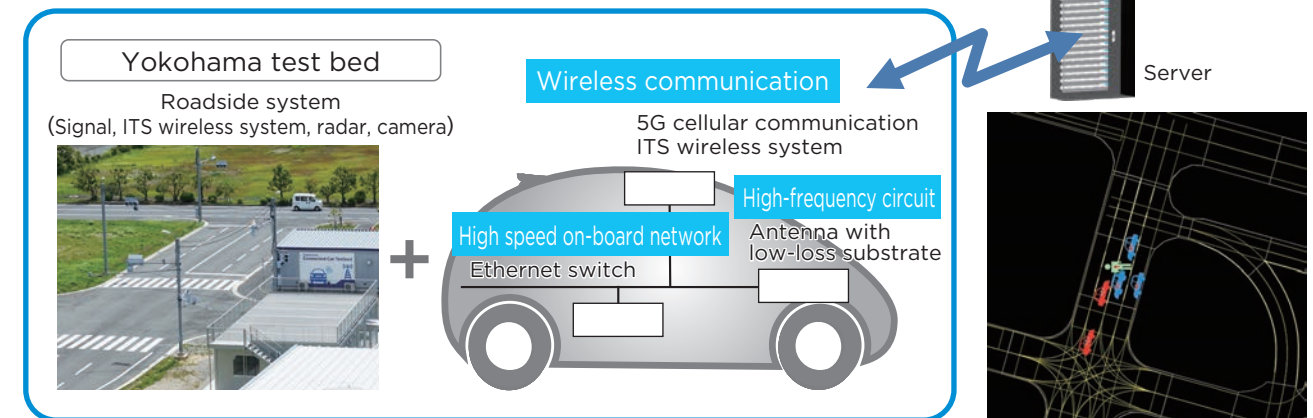

Electrification

To improve fuel economy (electricity consumption) and reduce CO₂ emissions, we are developing in-vehicle electric systems through vehicle-infrastructure cooperation. Our R&D encompasses vehicle charging functions, battery management, power conversion such as DCDC converters, and rectangular wires for high efficiency motors.

Rectangular wire for motors

Motor performance analysis

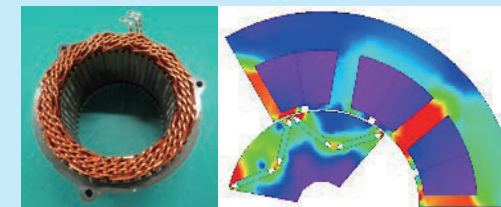

DCDC converter

Thermal & electromagnetic design

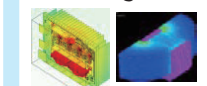

Low noise design

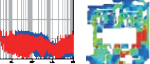

Charging system

- Collaboration on infrastructure
- Standardization strategy

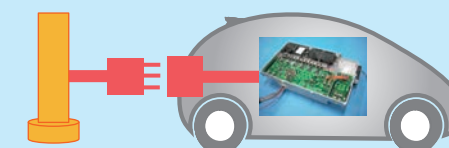

IoT battery management



BMU: Battery Management Unit

Power Systems R&D Center

We are developing new technologies and products in response to technological innovations in the electric power infrastructure sector, such as widespread use of renewable energy and sophisticated power infrastructure by using infocommunications technologies. More specifically, we are conducting R&D in elemental technologies to create products, equipment and systems that are essential for smart grids, i.e. future power networks.

Redox flow battery



In power systems using renewable energy generation, secondary batteries play a critical role in power storage and discharge in response to fluctuations in generated power. Redox flow batteries are suitable for irregular, highly fluctuating charge-discharge operation, and enable accurate monitoring and control of stored power. Therefore, they show promise as the most suitable batteries for smart grids designed for efficient use of renewables such as solar and wind. Based on our previous commercial experience, we are pushing ahead with development aiming to put the batteries into full-fledged use.

Power control system

Power control systems are used for grid-connected/isolated operation of renewables including solar power as well as secondary batteries in optimum conditions. We are developing advanced power control systems employing power electronics technology. Using power control systems with solar panels and secondary batteries, we also conduct development of distributed power systems for household and industrial use.

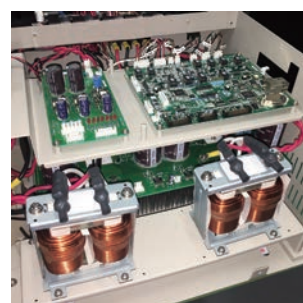

Superconducting tape

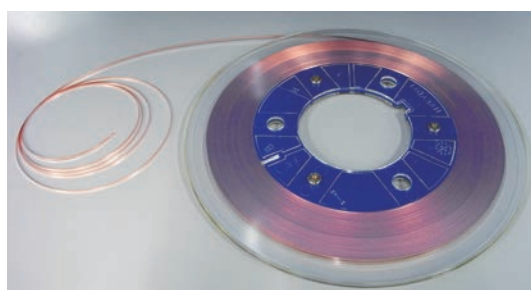

With the formation of high-temperature superconducting thin-film on our world's first low cost, low magnetism, high strength textured metal substrate, our superconducting tapes (size: 4 mm width, 150 μm thickness) enable current to flow higher than 200 A at a liquid nitrogen temperature of -196°C. We anticipate their widespread adoption in cables, electromagnets, nuclear magnetic resonance (NMR) devices and magnetic resonance imaging (MRI) devices.

Concentrator photovoltaic system



Concentrator photovoltaic (CPV) systems are the next generation in solar energy systems. The systems have approximately twice the power generation efficiency of silicon systems currently on the market, since photovoltaic cells are composed of a special compound semiconductor. As the concentrator panels are installed at an elevated position, the space underneath them is usable. The CPV panels we developed boast a lighter weight and less thickness compared with conventional ones.

New energy system

Our new energy system architecture (sEMSA™) enables optimal control of distributed power sources such as widespread photovoltaic generation, cogeneration and storage batteries as well as providing an energy cost reduction. Furthermore, sEMSA™ enables economically viable business for aggregators by putting together energy consumers, unifying energy management, adjusting power demand by way of demand response and stabilizing power networks.

- * Wi-SUN is a trademark or registered trademark of Wi-SUN Alliance, Inc.
- * Wi-Fi is a trademark or registered trademark of Wi-Fi Alliance.
- * ECHONET and ECHONET Lite are trademarks or registered trademarks of ECHONET CONSORTIUM.

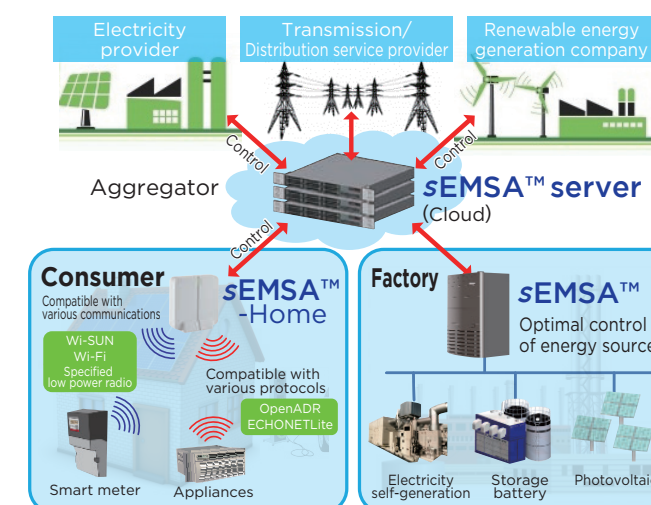

Power application system

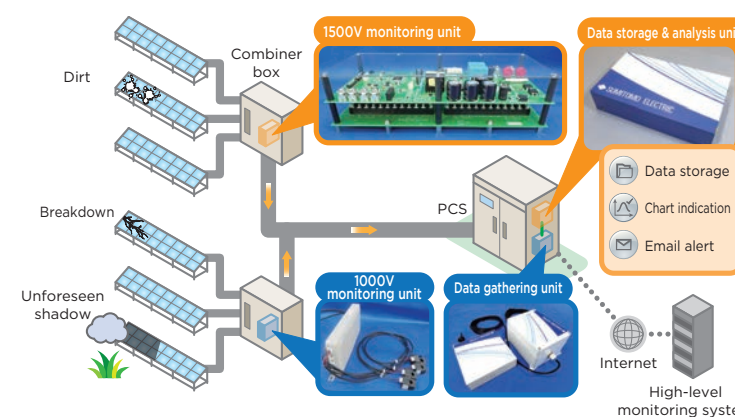

We are developing communication modules for smart meters and string monitoring systems for mega solar power plants by applying power line communication (PLC) technology. Our string monitoring systems incorporate sensing elements with current and voltage sensors to measure generated energy, and PLC communication elements to transmit sensor data. By using power lines, low-cost, highly-reliable systems can be installed without new communication and power lines. We will continue with development of power equipment monitoring systems applying artificial intelligence (AI) as well as IoT (Internet of Things) solutions employing PLC, radio communications and sensors.

Information Network R&D Center

We conduct R&D in optical network systems and wireless communications for fifth-generation mobile communications systems (5G) which support high-speed broadband communications. In the field of mobility systems, we develop millimeter-wave radar employing our wireless technology, traffic signal control using probe vehicle information, and vehicle routing and scheduling systems for MaaS (Mobility as a Service).

Optical network system

Broadband demand is growing from year to year with the emergence of new information services such as IoT, 5G wireless and autonomous driving. To support such social needs, we are conducting R&D encompassing 10G-EPON systems and their optical components that enable FTTH (fiber to the home) services and provide communication 10 times faster than current services, as well as Ethernet access devices that make possible low-delay and high-reliability services.

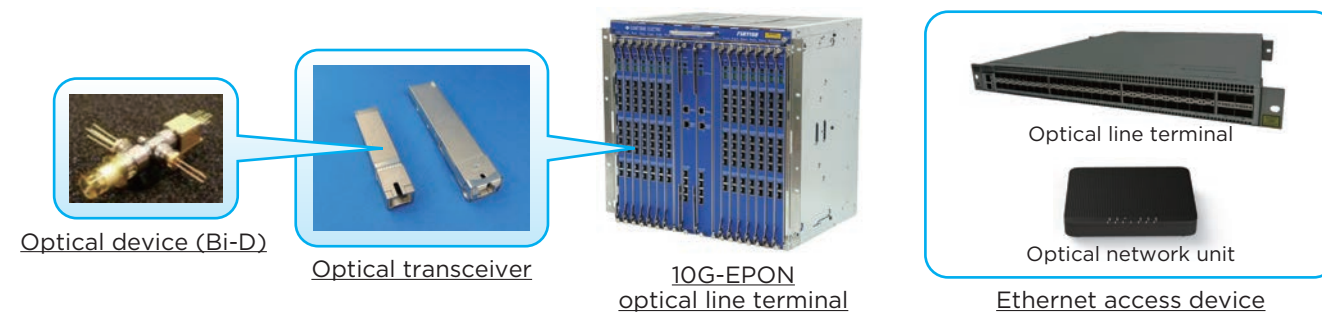

5G wireless access system

The fifth-generation mobile communications system (5G), which is expected to be introduced introduced 2020, features ultra-high-speed, low-delay, high-reliability and multiple connectivity and enables a world of IoT where not only conventional smartphones but everything is connected.

Based on our technology such as high-frequency amplifiers, antennas, and signal processing, we are developing wireless devices and modules for the 5G wireless infrastructure market and the connected car market.

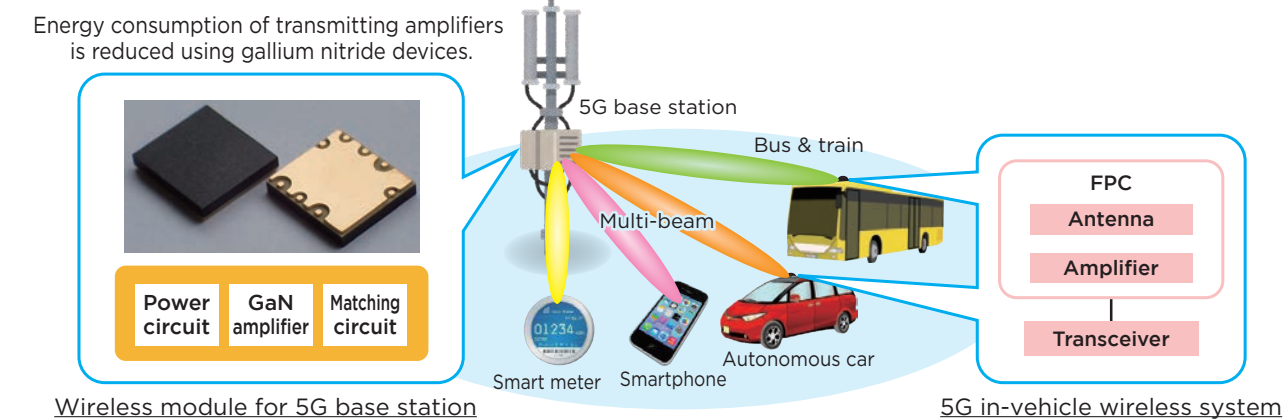

Mobility system

Millimeter-wave radar infrastructure system for autonomous driving

High performance sensors are essential to achieve autonomous driving that has been developing rapidly for practical use. Accordingly the need for millimeter-wave radar is growing.

Employing our wireless technologies to the traffic infrastructure market, we are developing millimeter wave radar infrastructure systems that detect the position and speed of vehicles as well as providing them with information. We aim to contribute to the realization of a safe, secure, and comfortable society.

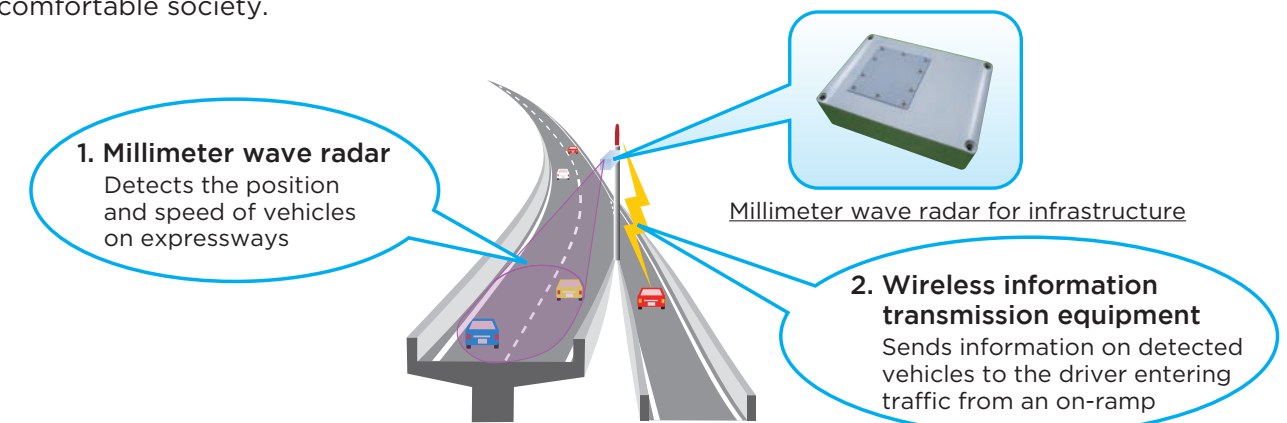

Next generation traffic system and vehicle routing and scheduling system for MaaS

To realize a society with a safe and secure, eco-friendly transportation system, we are tackling the development of advanced traffic systems and vehicle routing and scheduling systems for MaaS. Using AI for the processing of probe data such as vehicle position and speed, we are developing advanced signal control systems. We also conduct R&D on autonomous driving support systems which provide dynamically-changing traffic information for each lane several kilometers in advance. Moreover, we are working on the development of vehicle routing and scheduling systems for MaaS leveraging our expertise in real-time vehicle management and delivery planning.

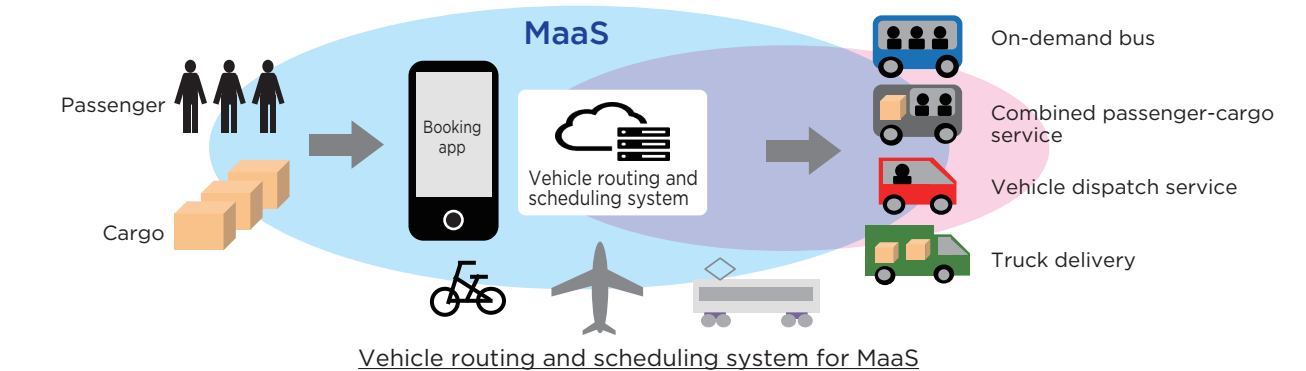
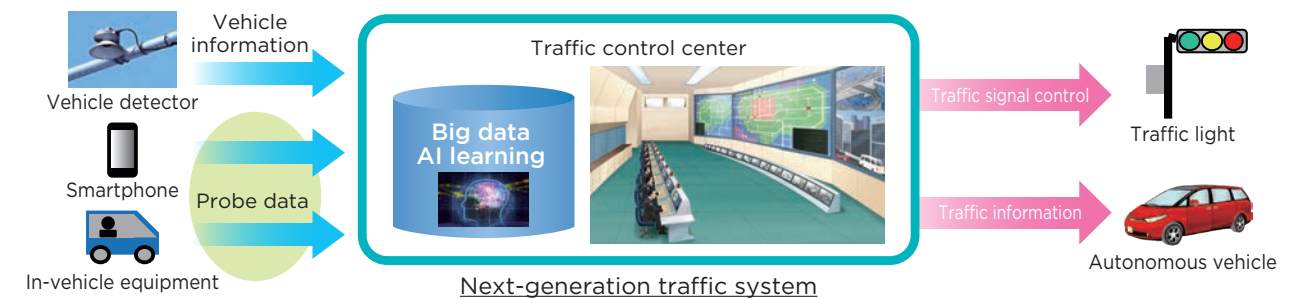

IoT R&D Center

In collaboration with plants in the SUMITOMO Electric Group, we are pushing ahead with the development of Internet of Things (IoT) technologies such as sensing systems, wireless communication, and big data analysis using AI to support manufacturing in our group, focusing on productivity improvement, automated inspection, predictive maintenance and work safety.

Factory IoT System

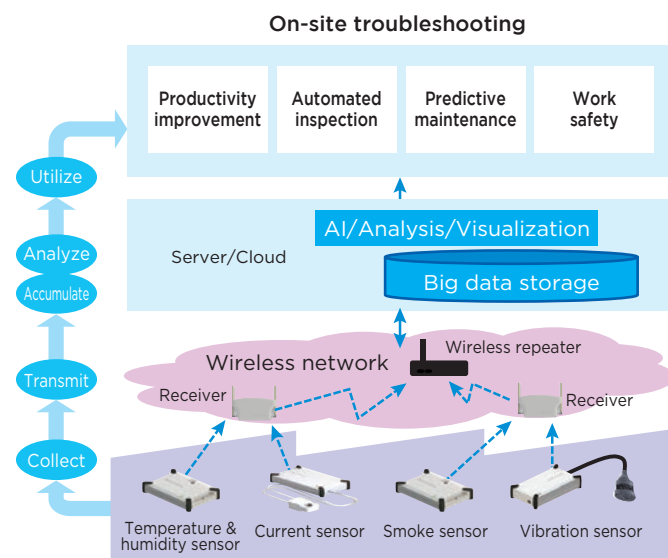

IoT technologies to collect and analyze data by connecting multiple sensors and devices to networks have been introduced increasingly into various manufacturing fields in recent years.

We are developing energy-saving wireless sensors to detect facility trouble and operating conditions and multi-hop wireless networks that enable economical introduction and user-friendly operation, based on our wireless technologies. We are also working on research to apply big data analysis to solve manufacturing challenges including productivity improvement and predictive failure monitoring for production equipment.

AI data analysis

Example: automated inspection

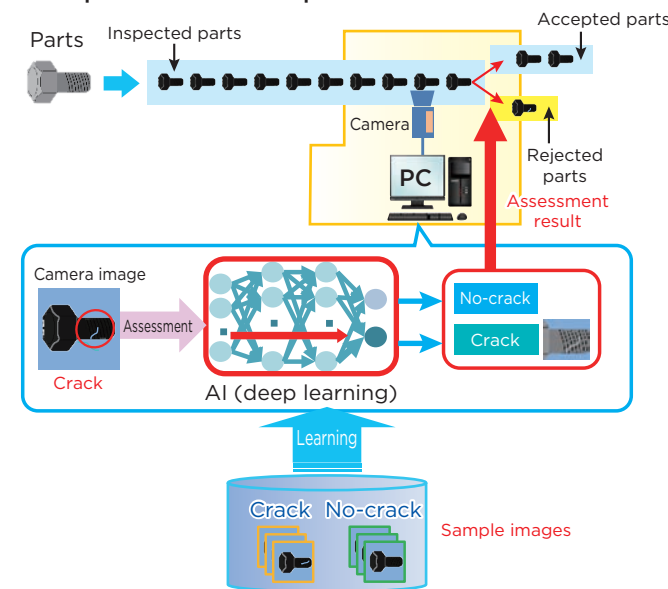

High precision, high speed analysis of a large amount of data collected in real time by IoT technologies is required for advanced manufacturing processes.

Through the development of AI & big data analysis, we are working to advance production processes in our businesses, including automated inspection.

Cyber-security R&D Office

We are developing cyberattack countermeasures for network-connected equipment in our five business segments, that is, infocommunications, automotive, environment and energy, electronics, and industrial materials. We are also engaged in research on advanced cybersecurity in cooperation with the SEI-AIST Cyber Security Collaborative Research Laboratory established jointly by Sumitomo Electric and the National Institute of Advanced Industrial Science and Technology (AIST).

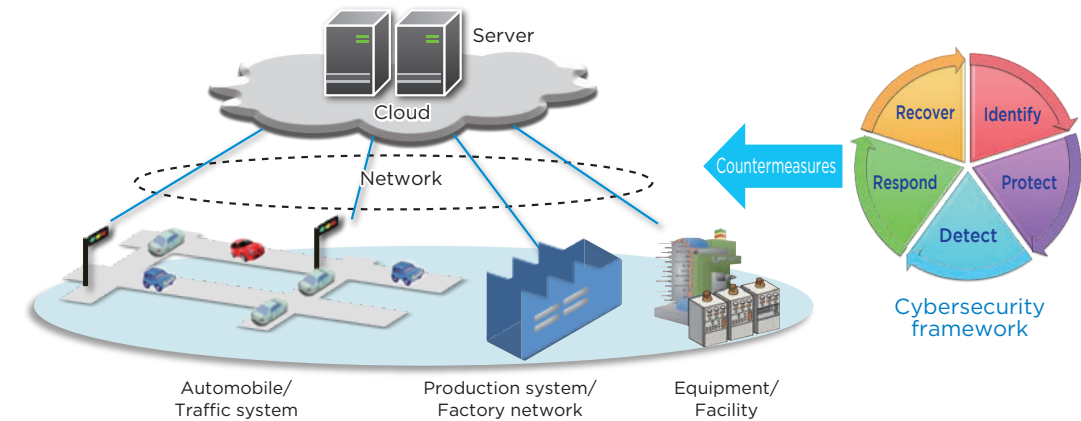

Automotive security

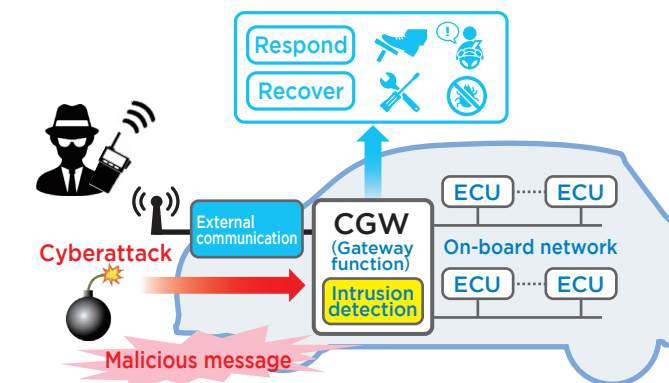

We are conducting R&D in automotive cybersecurity, which is required in conjunction with the appearance of autonomous driving and connected vehicles. The focus of our R&D is on unknown cyberattack detection for automotive networks employing analysis technology and machine learning, as well as on the application of the latest cryptographic technology to in-vehicle equipment and communications.

Cyber-physical security

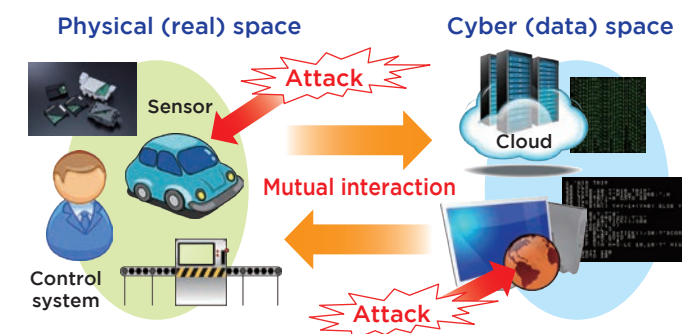

IoT development has brought about an expanding interaction between physical space and cyber-space, and new threats, such as cyber-physical attacks and physical-cyberattacks, are emerging. New security measures are needed. Our efforts are directed toward developing countermeasure technologies from both a hardware and software perspective.

Analysis Technology Research Center

We support the manufacturing and development of our group's products through advanced analysis and CAE (Computer Aided Engineering) technologies. Our main bases are in our Osaka, Itami and Yokohama works. We have bases in external facilities such as the Kyushu Synchrotron Light Research Center.

Strategic CAE infrastructure development

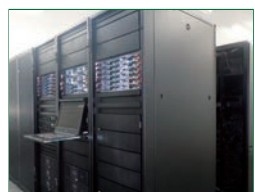

Lenovo NeXtScale System M5
 CPU: 912 cores [39 TFLOPS]
 Intel Xenon (Broadwell)
 Large capacity version (512GB memory) 64 cores
 SMP version (with GPGPU) 80 cores
 MPI version 768 cores
 Total of old and new servers 1329 cores [50 TFLOPS]

The use of CAE is not simply intended to improve product development efficiency. We regard it as a key technology for attaining market competitiveness. Our efforts are directed toward infrastructure development to enhance core functionality of CAE within the Sumitomo Electric Group.

*Lenovo and NeXtScale System are trademarks or registered trademarks of Lenovo and/or its affiliates.
 *Intel and Xenon are trademarks or registered trademarks of Intel Corporation.

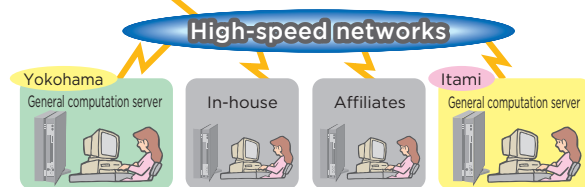

Dissemination and promotion of CAE analysis technology



Power cable accessory(EB-G) and analysis example

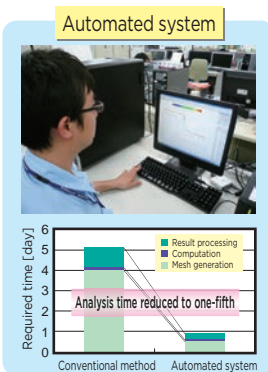

We promote the development and wide-spread use of CAE analysis techniques that are useful for product design. We work on the transfer of analysis techniques to our design departments using procedures that precisely meet designers' needs. Our efforts include providing training to designers and developing simplified/automatic analysis systems.

Electric wire service life prediction

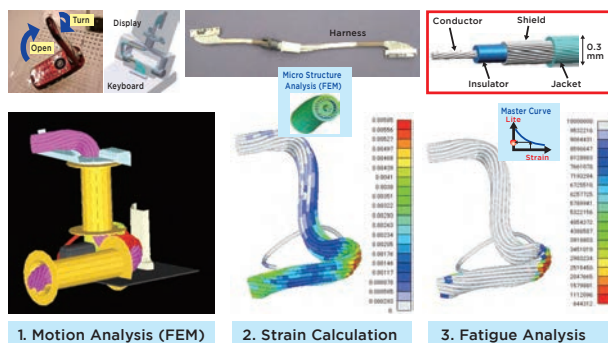

Mobile phone hinges, automotive doors and robot arms incorporate electric wires and cables in their moving parts. We are working on the development of CAE technology for predicting the service life of such wires and cables until breakage due to twisting and bending.

3D structure visualization

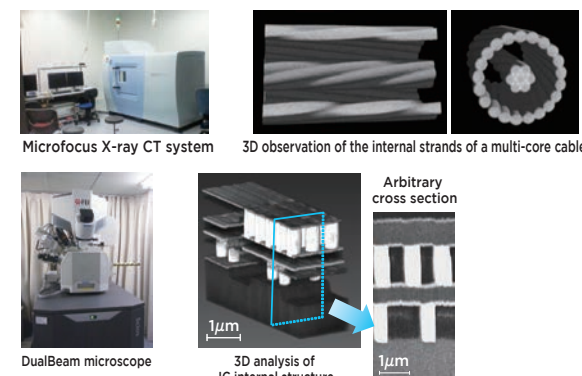

Three-dimensional structure visualization has been developed to observe the internal structures and targeted areas of composite materials, parts, products without changing the object. This technology is useful for improving product quality and developing solutions to problems.

Elemental mapping with sub-micron resolution

We are working on the development of technology to visualize, with high spatial resolution, the distribution of a low-concentration dopant that determines the characteristics of functional materials and parts, using an electron probe microanalyzer.

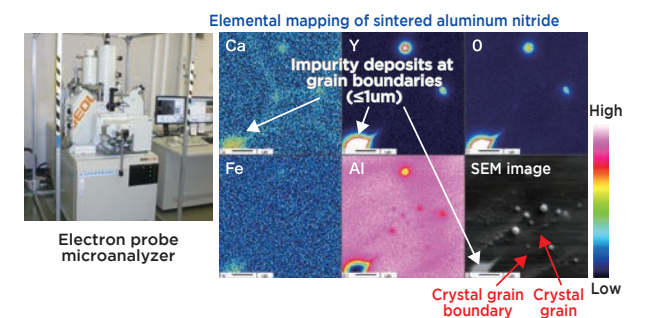

Fine structure analysis with nanometer-resolution

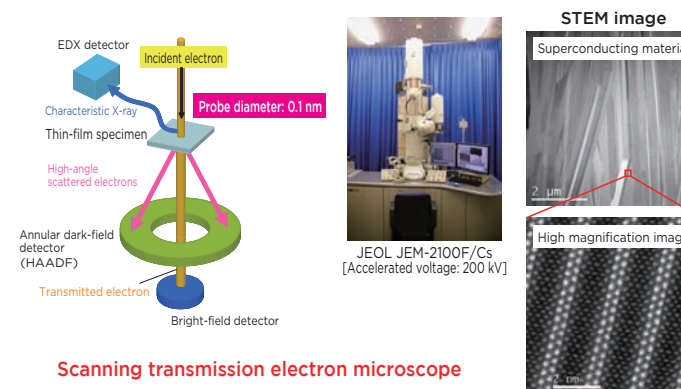

Our efforts are directed toward developing fine structure analysis focusing on scanning transmission electron microscopes as well as their practical application. Utilizing these technologies, we promote the development of high quality and highly functional materials and devices.

Synchrotron radiation and neutron analysis combined with simulation techniques

We are developing analysis technologies using synchrotron radiation and neutrons in order to investigate material structures at the atomic level and to perform in-situ measurement of chemical reactions. We utilize two beamlines of synchrotron radiation that are exclusive to Sumitomo Electric Group. Additionally using simulation techniques such as first-principles calculations, we are exploring new materials through the clarification of their high performance mechanism.

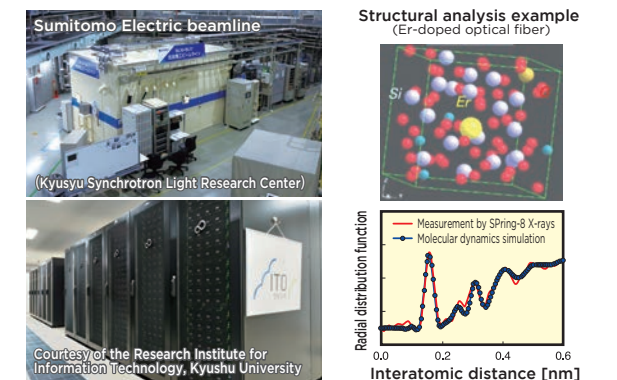

Advanced Materials Laboratory

We create unique metallic and inorganic materials through process innovation using our original ultra-high pressure and powder metallurgy technologies. We contribute to the expansion of our business in industrial materials and other business fields through the development of highly functional materials and parts including cemented carbide cutting tools, diamonds, ceramics, sintered ferrous alloy parts, and special steel wires.

Powder metallurgy

We have developed cemented carbide and cermet for cutting tools and sintered ferrous alloy and aluminum alloy parts for automobiles. We are now working on the development of magnetic materials (magnetic cores and magnets) and related products which contribute to the higher performance of motors and sensors.



Soft magnetic composites



Powder metal gears

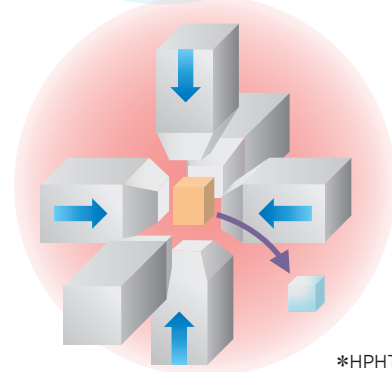
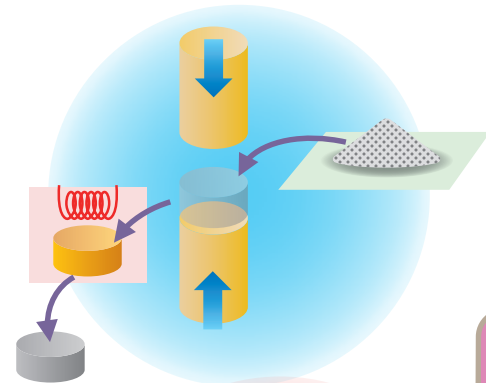

*HPHT: High Pressure and High Temperature

Ultra-high pressure technologies

We have developed a sintered diamond, a sintered CBN (cubic boron nitride) as well as a synthesized single crystal diamond employing our high pressure techniques. We are now working on the development of nano-polycrystalline diamond and applied products, which consist of nano-sized crystals and are harder than natural diamond.



Nano-polycrystalline diamonds

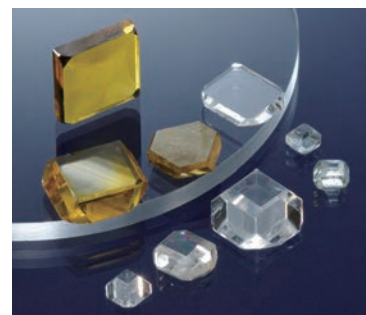

Synthetic single crystal diamonds

*Received 2013 Best 10 New Products Awards sponsored by Nikkan Kogyo Shimbun and 2014 Okochi Memorial Technology Prize

Thin film coating technology

We are developing a coating technology to apply a ceramic film on cutting tools with high hardness and good adhesion.

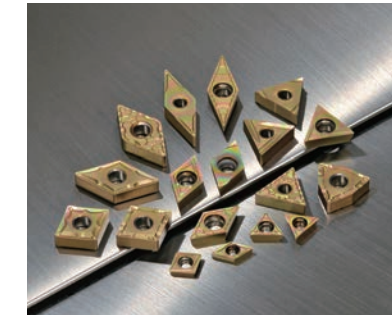

PVD coated inserts



Turning using insert

Machining technology

We are developing high value cutting tools by using machining monitoring techniques and advanced tool fabrication processes including 3D printing.

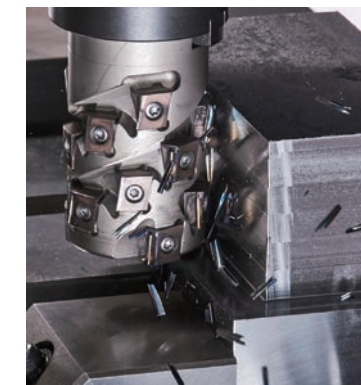

High-efficiency milling

Wire drawing technology

We are developing high performance spring wires and high strength steel cords employing our drawing technology with heat treatment and electroplating.



Steel cords



High strength wires for valve springs

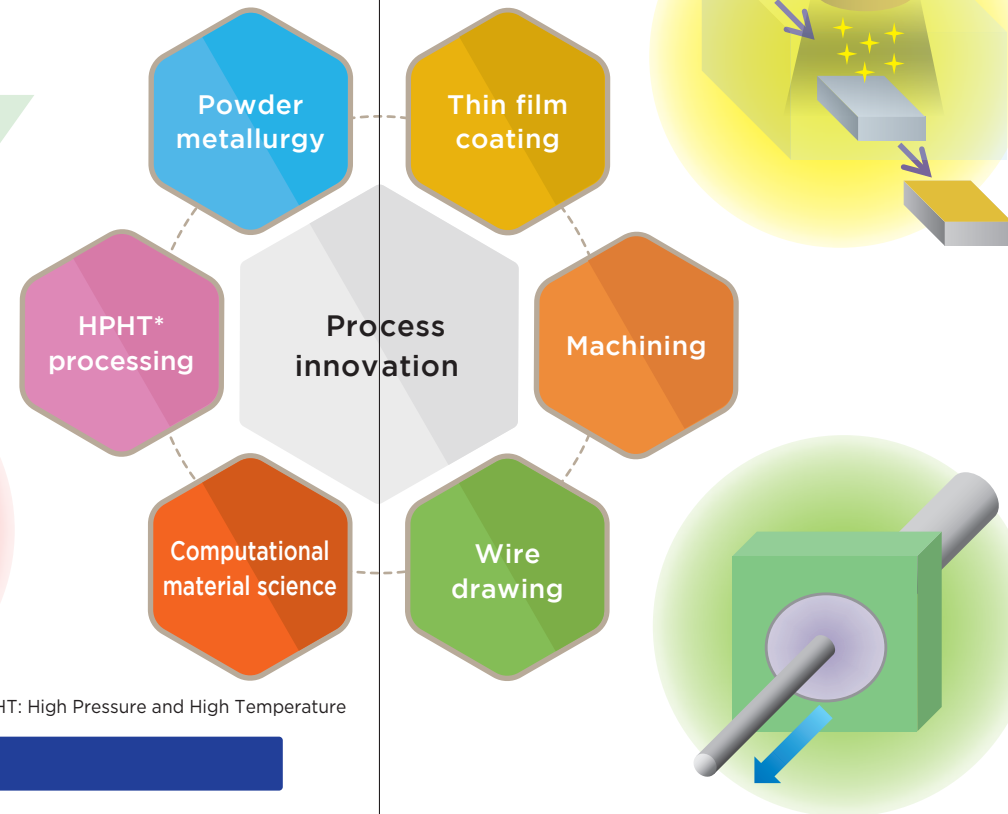

Energy and Electronics Materials Laboratory

We contribute to the development of products and technologies in the Group's extensive business fields by leveraging our core technologies for metal, inorganic, and polymer materials as well as fine circuit fabrication.

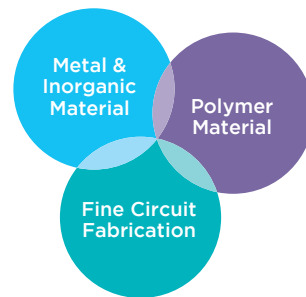

Metal and inorganic material technology

For weight reduction of wiring materials in automobiles, we are conducting the development of aluminum alloy wires and their application to wiring harnesses in collaboration within our group, using our technologies for continuous casting and plastic forming.



Aluminum alloy wire

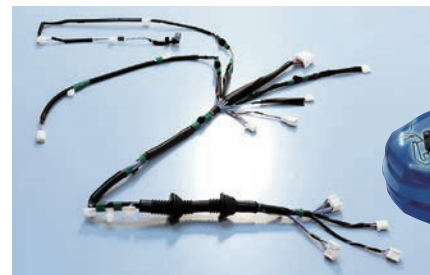

Aluminum wiring harness

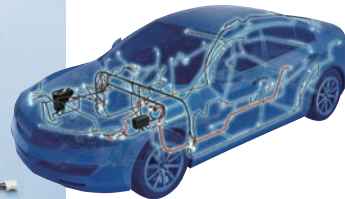

Our plating technology, which was initially developed from gold, has produced Celmet™ and other unique materials.

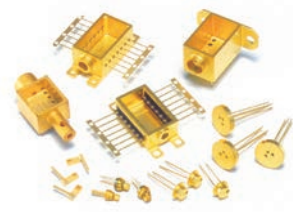

Gold plated products

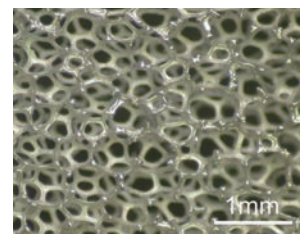

Heatproof and anticorrosion Celmet

Employing our composite material technologies, we are developing new materials designed to have well-balanced properties such as their thermal conductivity and expansion rate.

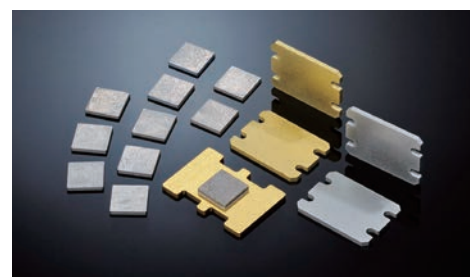

Ag-Dia heatspreader

Polymer material technology

Employing polymer synthesis and resin formulation technologies, we have been developing a wide array of products such as electric wires and cables in the fields of environment and energy, electronics, and automotive, as well as magnet wires for environment-friendly vehicles.

We are also working on the development of newly functional and high performance polymer materials through nano-sized material structure control (polymer alloy and nano-composite).

Polymer synthesis and resin formulation

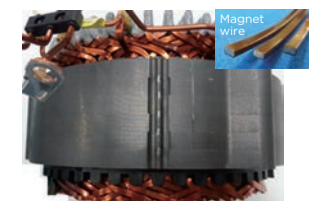
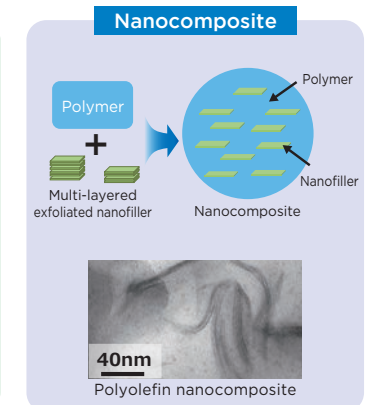
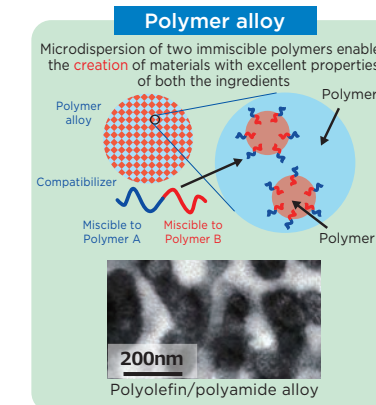

Magnet wire for eco-friendly vehicles



Crosslinked polyethylene insulated ultra-high voltage DC cable



Composite cable for electric powered parking brake



Heat-shrink tubing

Fine circuit fabrication technology

To accommodate the need for high-density and fine circuits, we are developing nanoparticles of metals as well as their ink and paste. We are also working on their application to our electronics products.

Synthesis & application of metal nanoparticles

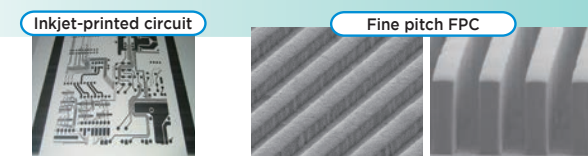
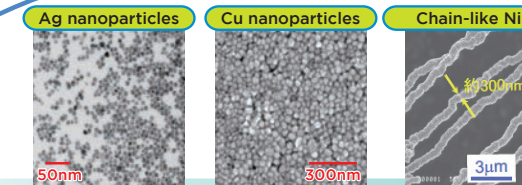

Paste formulation & Printing Circuit fabrication

- Smartphone
- Touch panel display
- Wearable terminal
- Actuator coil

Optical Communications Laboratory

To contribute to the development of a connected society, we are pushing ahead with continuous innovation in optical fiber technologies fundamental to broadband communication networks and their expansion into data centers and households. We are also working on the application of optical technologies to new fields.

Optical fiber



Z-PLUS Fiber™ 150

Since the early 1970s, we have developed a vapor-phase axial deposition (VAD) method, a Japanese original technology, to produce optical fibers efficiently. Based on this technology, we have been making innovations in advanced optical fibers and related technologies to produce these fibers efficiently.

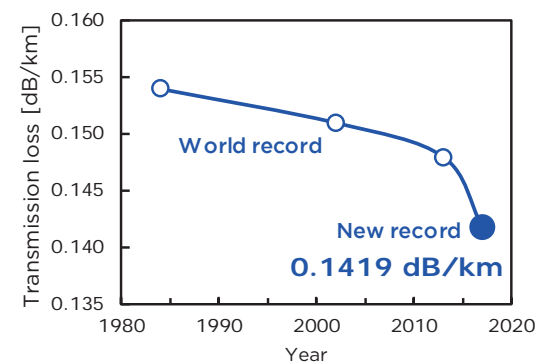

Ultra-low loss optical fiber with pure silica core

Our ultra-low loss optical fibers based on pure-silica core technology are best for long-distance high-capacity communications, such as submarine optical cables. After our continuous innovation in glass and coating technologies, we achieved a transmission loss of 0.1419 dB/km at 1560 nm wavelength in 2017, which is a new record for lowest loss.

Next generation optical fibers/Connection technologies

We are conducting R&D in innovative multi-core optical fibers (MCF) and related connection technology that overcomes the limitations of conventional standard single-core fiber and paves the way for petabit optical transmission.

Multi-core optical fibers in practical use

Multi-core optical fibers having the same cladding diameter (125μm) as standard optical fibers

4 low loss coupled cores for long distance transmission ¹⁾
4 uncoupled cores having optical compatibility with standard optical fibers ²⁾
8 uncoupled cores for short distance transmission in the 1.31 μm wavelength region ³⁾

Set a world record for transmission capacity for optical fibers (September 2017)

19 uncoupled cores and 6 modes (i.e. 114 spatial channels) for 10 petabit/s transmission ⁴⁾

Multi-core/single-core conversion connector

Multi-core optical fiber
Single-core optical fiber bundle
7 single-core optical fibers

1) <http://www.sei.co.jp/company/press/2016/03/prs023.html>
2) <http://www.ntt.co.jp/news2017/1708/170808b.html>
<http://www.sei.co.jp/company/press/2017/prs083.pdf>

3) <http://www.sei.co.jp/company/press/2015/03/prs022.html>
4) <http://www.kddi-research.jp/newsrelease/2017/092201.html>
<http://www.sei.co.jp/company/press/2017/prs097.pdf>

High-capacity interconnection technologies

We are developing high-capacity interconnections using our metal and optical cable technologies for rapidly expanding data centers, where high speed as well as low power consumption are required. We are also working on the development of new high speed cables for appliances.

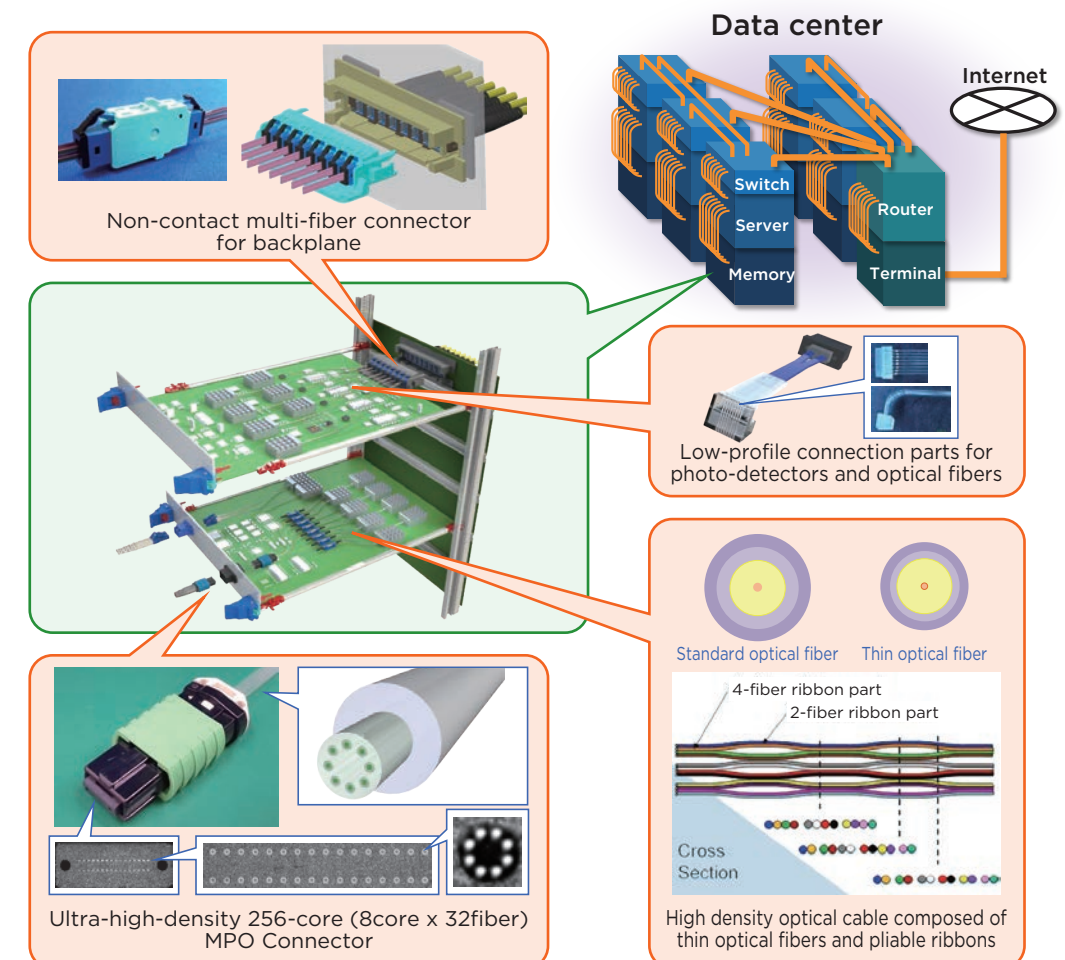

Transmission Devices Laboratory

Our unique technology encompasses semiconductor crystal growth, epitaxy, processing, high-precision assembly of optical and electronic devices, and optical transceiver design. Using the complete spectrum of technology we possess, we are developing advanced compound semiconductor materials and related products for two major communications markets, that is, optics and wireless. We also aim to enter the non-communications market employing our cultivated elemental technologies.

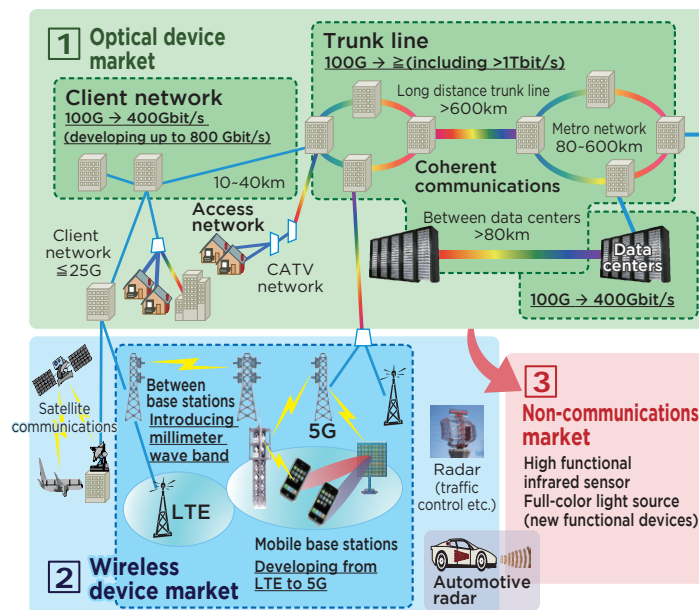

Compound semiconductors and their applications

| Material | Photonic device | Electronic device |
|----------|---|---|
| GaAs | Red laser Visible/Infrared LED (DVD, PC, automotive, outdoor display) | High frequency IC Power amplifier (mobile phone, wireless base station, satellite communications) |
| InP | Infrared laser/ Photodetector (optical communications) | |
| GaN | Blue-Violet laser Blue/White LED (Blu-ray, LCD backlight, outdoor display, lightning) | High frequency power device High power, low loss device (wireless base station, power controller, electric vehicle) |
| AlN | UV light emitter (sterilization, cleaning, processing) | Next generation power device (high frequency power device) |

We are a pioneer in compound semiconductors, which are applied to various products where silicon cannot be used. We have commercialized a wide array of materials, and are now developing a crystal growth process with higher quality and a larger diameter as well as new materials for cutting-edge electronic devices.

*Blu-ray is a trademark or registered trademark of Blu-ray Disc Association.

Optical device



Tunable light source Multi-level modulator Coherent receiver



Integrated TOSA/ROSA Optical transceiver (QSFP-DD)

We are developing semiconductor devices for optical-electrical signal conversion in optical communications systems.

In trunk lines, digital coherent technology is used to realize 10 Tbit/s-class ultra-high capacity transmission. As key components, we are developing high-power tunable narrow-linewidth light sources, multi-level modulators, and coherent receivers employing our compound semiconductor technologies.

For client networks and data centers, we are developing optical subassemblies (OSA) and higher data rate optical transceivers. To cope with the rapid growth of optical network capacity, we are tackling miniaturizing and energy-saving technologies as well as higher transmission speed.

Wireless device

We developed gallium arsenide (GaAs) HEMTs*1 ahead of our competitors and have supported the expansion of wireless communications. Applying this technology to gallium nitride (GaN), we have greatly contributed to the miniaturization and higher efficiency of high-speed mobile communications (LTE) base stations.

In addition, for the introduction of next generation 5G networks, we aim to create advanced devices with higher frequency and higher efficiency. Using high power and high efficiency features, we are pushing ahead with applications for larger communications capacity among base stations and satellites as well as solid state radar. HEMTs are integrated into MMICs*2, which are used in millimeter wave automotive radar.

*1 HEMT: High Electron Mobility Transistor
*2 MMIC: Monolithic Microwave Integrated Circuit
*3 WiMax is a trademark or registered trademark of WiMax Forum.

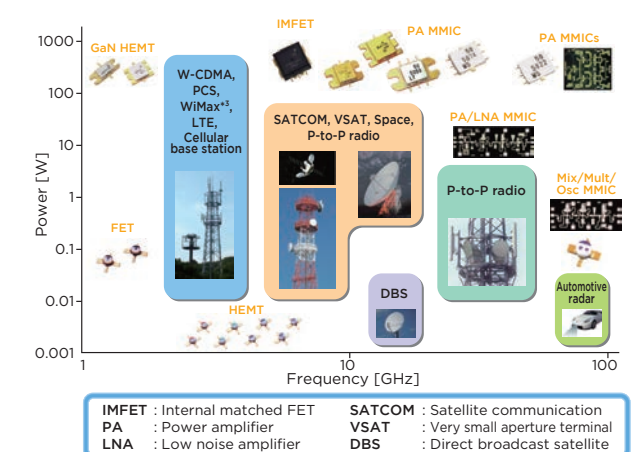

Ultracompact RGB laser module

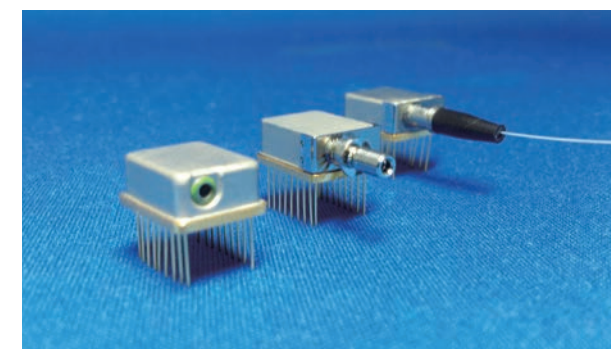

We are developing ultracompact RGB laser modules combining our visible laser diode technologies as well as precision assembling processes for transmission devices. Semiconductor light sources of the three primary colors: red, green and blue, are integrated with optical components and thermoelectric coolers which enable effective temperature control and stable laser oscillation. We have achieved clear projected images using our laser alignment technique for the three primary colors. Wide application to head-up displays, projectors, pointers, illuminators, and other industrial equipment is promising.

Infrared sensing device

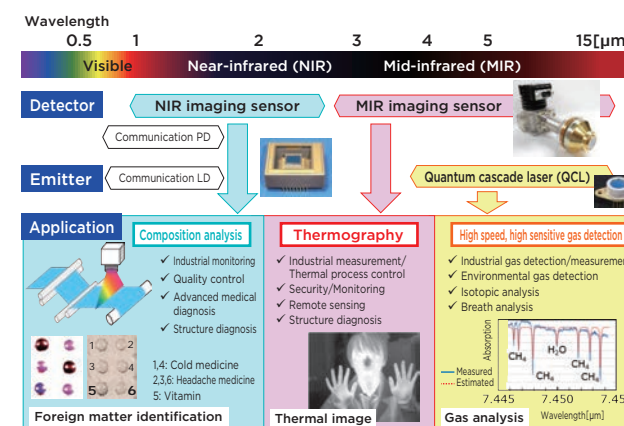

We are developing quantum well infrared imaging sensors using elemental technologies from photodetectors for optical communications. With higher sensitivity, our sensors are suitable for microanalysis equipment and diagnosis systems which can visualize slight temperature differences. We are also conducting R&D in mid-infrared quantum cascade lasers for highly sensitive gas detection.

Power Device Development Division

Silicon carbide (SiC) is a promising material for high power and high efficiency power devices which promote an advanced, energy-saving society. We are developing SiC crystals and epitaxial wafers using high-quality and cost effective growth technology (MPZ™*). Newly designed SiC power transistors and modules with low power loss and high blocking voltage are also being developed. Our power system equipment will incorporate these SiC power devices in the near future.

* MPZ: **M**ulti-**P**arameter and **Z**one controlled SiC Growth Technology



High quality SiC crystal and epitaxial wafer

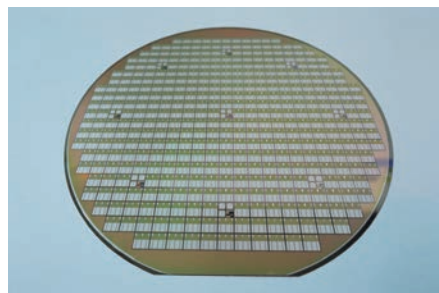

SiC transistors on epitaxial wafer

We are developing high quality and large diameter SiC crystals using MPZ™ technology that accurately controls temperature and reaction processes during crystal growth.

Single crystal epitaxial layers are grown on sliced and mirror polished SiC wafers using chemical vapor deposition (CVD).

MPZ™ offers high quality epitaxial wafers with world top-level uniformity, and enables a defect-free area of more than 99% of the wafer surface. The wafers have been rolled out under the trade name of EpiEra™, and were awarded 2018 Semiconductor of the

Year Grand Prix Award in the electronic material division, which is sponsored by Electronic Device Industry News. SiC power transistors are fabricated on epitaxial wafers through semiconductor processes such as ion implantation, insulating film formation, and electrode formation.

High-efficiency SiC power transistor

V-grooved trench metal oxide semiconductor field effect transistors (VMOSFETs) have been newly developed by utilizing unique crystal planes. VMOSFETs have superior features such as high efficiency, high blocking voltage, and high stability under severe environments.

A large current (200 A per single chip) has been achieved, which is suitable for electric vehicles (EVs) and hybrid electric vehicles (HEVs).

Furthermore, as the theoretical limit of SiC is approached, we are developing next-generation VMOSFETs with the world's lowest on-resistance in collaboration with the National Institute of Advanced Industrial Science and Technology.

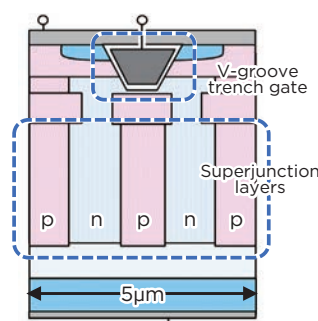

Structure and on-resistance of next generation VMOSFET

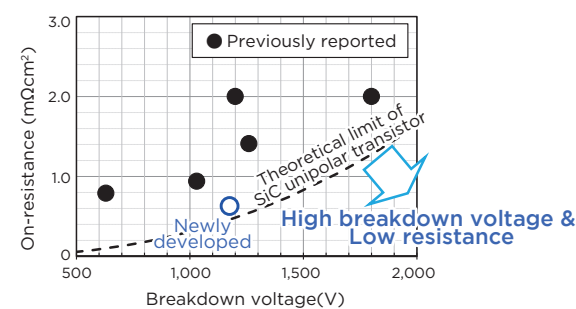

Frontier Technologies Laboratory

Looking ahead to the impact of the world's technological and social changes on our business, we conduct research on and development of next-generation technologies.

Next-generation electric wire

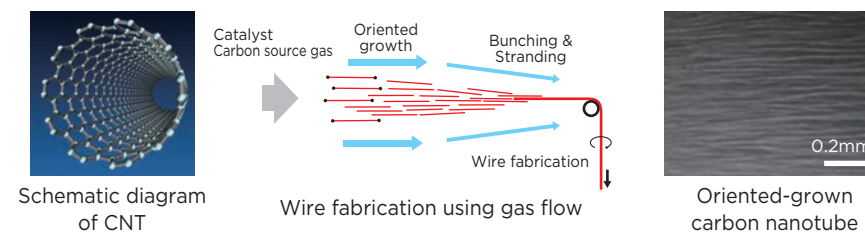

Carbon nanotubes (CNTs) are made of carbon which will not be depleted. We are researching their application to electric wire products employing our unique growth method.

Next-generation energy

Hydrogen is an energy resource that can be used without greenhouse gas emissions. We are developing elemental technologies required for a global system for a hydrogen society. Moreover, we are conducting research on a membrane refining technique applying our expertise in optical fiber.

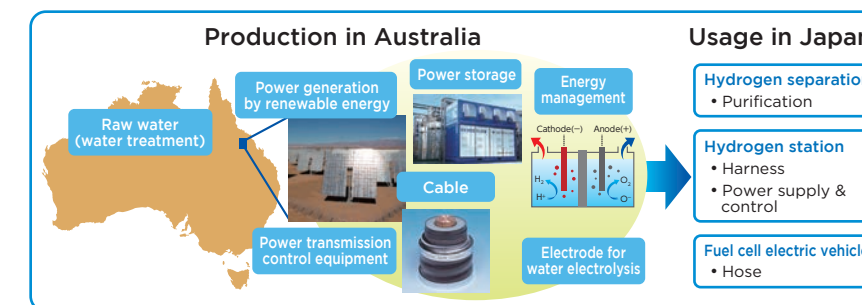

Conception of global system for hydrogen society

Development of membrane separation

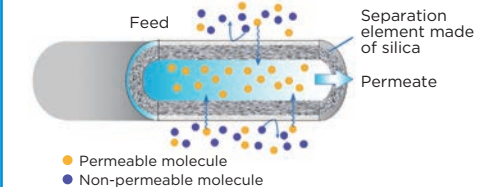

Feature

- Refining of gases, ethanol and water

R&D Planning & Administration Division

Aiming to carry out our mid-term management plan (22 VISION) that sets forth the managerial direction of our company, we administer projects based on the achievements of our R&D unit.

For the growth of our technology and businesses, we support the launch of new research initiatives and commercialization of the fruit of our developments. We also promote collaboration within our group, joint research with universities and research institutions, participation in national projects, and cooperation with other companies. Regarding the US and Europe, we have set up local bases, we gather the latest information, and encourage entry to development projects.

Furthermore, we hold training workshops to nurture future leaders and networking between them.