

AI-base Water Quality Prediction Technology for Sewage Treatment Plant Discharges

Akira OKUBO*, Terumi TAKEHARA, Lan HUANG, Mitsuru MORIMOTO, and Kotaro KASUYA

Nissin Electric Co.,Ltd. has developed a technology that uses artificial intelligence to predict the chemical oxygen demand (COD), total nitrogen content (TN), and total phosphorus content (TP) in discharged water two hours after measurement, based on the past measurement data accumulated in the monitoring and control equipment of sewage treatment plants. The technology enables maintenance staff to change the operation of sewage treatment before the water quality deteriorates. This prevents the deterioration of the water quality without effort.

Keywords: sewage, AI, prediction, discharged water quality, monitoring and control

1. Introduction

Effluent standards for water discharged from sewage treatment plants are stipulated by the Water Pollution Prevention Act, and the chemical oxygen demand (COD) is subject to control. Total nitrogen content (TN) and total phosphorus content (TP) are additionally subject to regulation at sewage treatment plants in the Setouchi region and other designated areas. To satisfy the standards, automatic measuring devices are used to monitor these controlled and regulated parameters at sewage treatment plants; however, depending on the quality of polluted water flowing into sewage treatment plants and sewage treatment process conditions, the discharged water quality may deteriorate. To restore such deteriorated water quality to normal, the experience and expertise of maintenance staff are required, and since a certain amount of time needs to elapse, the labor of maintenance staff is also required.

To enable maintenance staff to detect water quality deterioration in advance, Nissin Electric Co.,Ltd. has developed a technology to predict future water quality changes using artificial intelligence (AI) based on past actual data of these controlled and regulated parameters. This technology can help to prevent water quality deterioration while reducing the burden on maintenance staff.

2. Sewage Treatment Plant Structure and Technology Development Requirements

A typical sewage treatment plant has the following structure (Fig. 1). Influent sewage is discharged into rivers and other waters after undergoing the treatment process. However, treatment steps differ slightly depending on the scale of treatment plants and the treatment method. In each treatment step, various sensors are used to monitor the treatment status, and the measurement results (sensor readings) are stored on the monitoring and control equipment.

In developing this technology, we took the following matters into consideration so that it can be applied to a variety of sewage treatment plants.

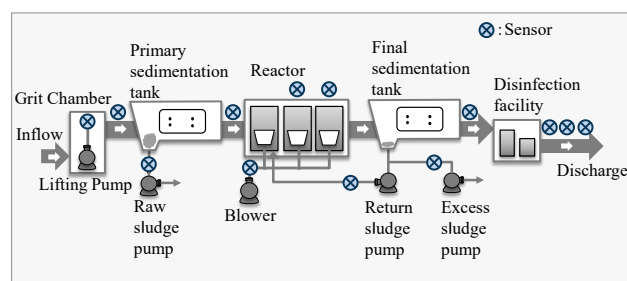

Fig.1. Schematic diagram of sewage treatment plant

Table 1. Sensors used

Input sensor name	Used/Not used	Input/Output	Remarks
Influent sewage temperature	Not used		Whether or not it is installed depends on the treatment plant. (Not common)
Influent sewage PH	Not used		Whether or not it is installed depends on the treatment plant. (Not common)
Amount of water pumped by the pump	Used	Input	
Recycle flow rate	Used	Input	
Initial settlement inflow flow rate	Not used		Not different from variation in the amount of water pumped by the pump.
Raw sludge withdrawal flow rate	Not used		Not applicable because of fixed-cycle and fixed-quantity operation.
Raw sludge concentration	Not used		Whether or not it is installed depends on the treatment plant. (Not common)
Reactor influent flow rate	Used	Input	
Reactor air feed rate	Used	Input	
Dissolved oxygen (DO) concentration	Used	Input	
Mixed liquor suspended solids (MLSS) concentration	Used	Input	
Reactor pH	Not used		Whether or not it is installed depends on the treatment plant. (Not common)
Oxidation reduction potential (ORP)	Not used		Whether or not it is installed depends on the treatment method. (Not common)
Reactor water temperature	Not used		Whether or not it is installed depends on the treatment plant. (Not common)
Circulating water flow rate	Not used		Whether or not it is installed depends on the treatment method. (Not common)
Returned sludge flow rate	Not used		Not different from variation in the amount of water pumped by the pump because of flow rate ratio operation.
Returned sludge concentration	Used	Input	
Excess sludge withdrawal flow rate	Not used		Not applicable because of fixed-cycle and fixed-quantity operation.
Sodium hypochlorite feeding flow rate	Not used		Not different from variation in the amount of water pumped by the pump because of flow rate ratio operation.
Residual chlorine concentration	Not used		Whether or not it is installed depends on the treatment plant. (Not common)
Final effluent flow rate	Not used		Not different from variation in the amount of water pumped by the pump.
COD	Used	Input/Output	
TN	Used	Input/Output	
TP	Used	Input/Output	

- (1) No special or new sensors are used.
- (2) Only general-purpose sensors that are common to various sewage treatment plants are used (Table 1).
- (3) The mounting position of each sensor does not matter.
- (4) This technology can be used regardless of the number of treatment waterways or the treatment method.

3. Techniques for Predicting Discharged Water Quality

In this chapter, the techniques used to predict the discharged water quality are described. Sections 1 and 2 describe the data organization method and the prediction method, respectively.

3-1 Data organization method

Input values from general-purpose sensors contain unintended behaviors (such as high-frequency noise). Therefore, we used a low-pass filter (LPF) to remove the high-frequency noise.

The data before and after the application of the LPF is shown in Fig. 2. When the LPF is applied, a phase delay (After (fn) in Fig. 2) occurs, which affects our development purpose, namely the prediction of the discharged water quality. In this technology, to prevent the phase delay, we applied the LPF twice to the target section—once in the forward direction and once in the reverse direction—to achieve zero phase (After (yn) in Fig. 2).

The recurrence relation of the LPF applied is shown below.

< Recurrence relation >

$$f_n = x_0 (-N < n < 0)$$

$$f_n = \sum_{k=0}^N b_k x_{n-k} - \sum_{k=1}^N a_k f_{n-k} \quad (0 \leq n < l)$$

$$y_n = f_{l-1} \quad (l \leq n < l + N)$$

$$y_n = \sum_{k=0}^N b_k f_{n+k} - \sum_{k=1}^N a_k y_{n+k} \quad (0 \leq n < l)$$

X_n : nth input data value
 l : Data length of input data

a, b, N : Parameters of LPF

f_n : nth LPF (forward direction) output data value
 y_n : nth LPF (reverse direction) output data value

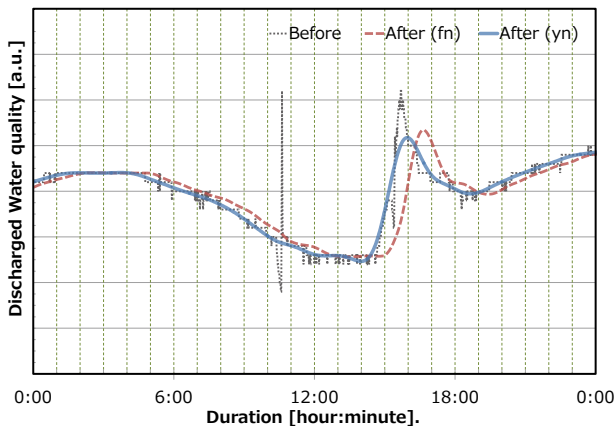

Fig. 2. Time-series date before and after LPF application

3-2 Prediction method

Since the discharged water quality depends on the surrounding environment of the sewage treatment plant, it is necessary that the calendar be taken into account when predicting the discharge water quality. In this technology, we used the Long Short-Term Memory (LSTM) neural network, which is a method of AI technology. LSTM has the advantage of being able to consider long-term dependencies because it has a structure that allows the network to utilize short-term memory for a long time.

Figures 3 and 4 show the conceptual drawings of learning and predicting the discharged water quality by LSTM, respectively. We used LSTM to learn the relationships between the measured values $M(T - V)$ to $M(T)$ and the measured value $M(T + W)$ from the past time-series data to which the LPF was applied by shifting data, as shown in Fig. 3, and generated a learning model.

We built a system for predicting the data after W minutes (predicted value $P(T + W)$) by inputting the most recent time-series data to which the LPF was applied (measured values $M(T - V)$ to $M(T)$) into the learning model.

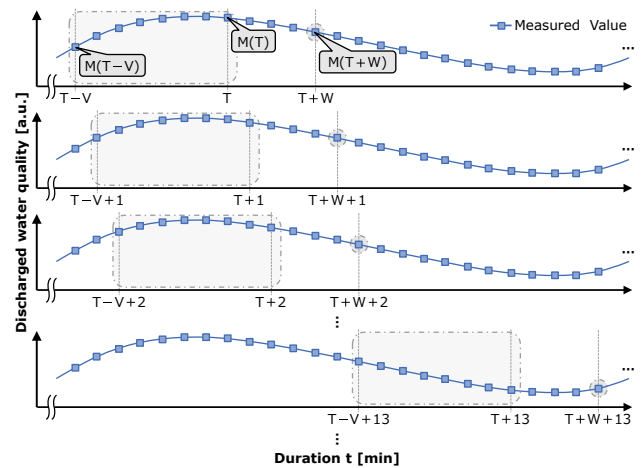

Fig. 3. Conceptual drawings of learning with LSTM

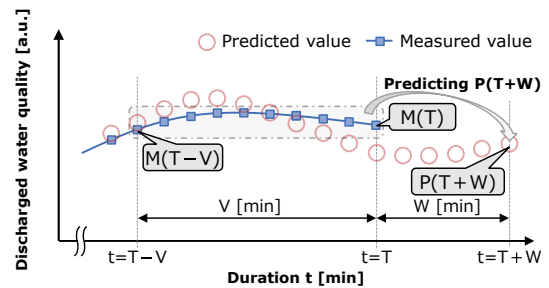

Fig. 4. Conceptual drawings of prediction by LSTM

4. Evaluation of Discharged Water Quality Prediction

This chapter describes the results of the evaluation of the prediction of discharged water quality using data from a certain treatment plant as a sample. An outline of the

sample treatment plant, the judgment criteria, the evaluation results based on past data of the sample treatment plant and the results of the on-site verification at the sample treatment plant are described in Sections 1, 2, 3 and 4, respectively.

4-1 Outline of the sample treatment plant

Figure 5 shows a schematic diagram of the sample treatment plant that was used to predict the discharged water quality. The sample treatment plant has adopted a system in which influent sewage is divided into three, each of which undergoes different treatment steps, and finally is discharged together.

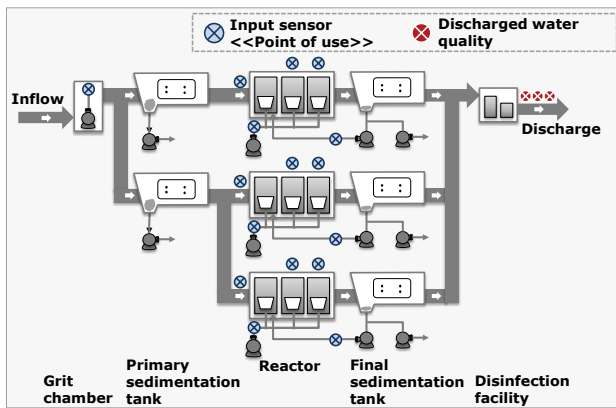

Fig. 5. Simplified model of the sample treatment plant

4-2 Judgment criteria for the developed technology

We determined the judgment criteria for the prediction of discharged water quality based on the error $E(t)$ ($= |\text{predicted value } P(t) - \text{measured value } M(t)|$) of each discharged water quality parameter (COD, TP, TN). A conceptual drawing of the errors is shown in Fig. 6. Table 2 shows the judgment criteria.

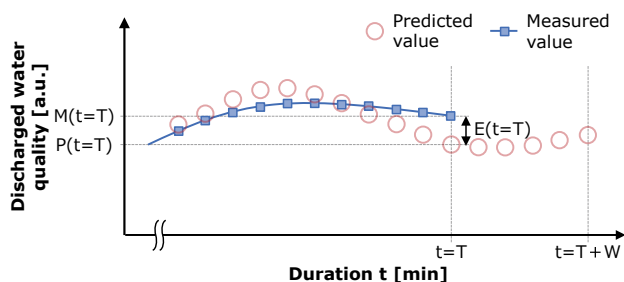

Fig. 6. Conceptual drawings of error in predicting discharged water quality

Table 2. Judgment criteria for errors in discharged water quality parameters

Discharged water quality	Judgment criteria[mg/L]
COD	Error $E(t) \leq 2.0$
TN	Error $E(t) \leq 10.0$
TP	Error $E(t) \leq 1.0$

4-3 Evaluation results based on past data

We created and evaluated the learning model using past time-series data (from January 1 to November 5, 2019) at the sample treatment plant. The created learning model has learned the relationships between the measured values $M(T - 1,440)$ through $M(T)$ and the measured value $M(T + 120)$ extracted from the past time-series data. Table 3 shows the evaluation results for the error $E(t)$ of the created learning model, and Fig. 7 (a) through Fig. 7 (c) are

Table 3. Evaluation results based on past data at the sample treatment plant

Discharged water quality	Error $E(t)$ [mg/L]			Judgment
	Maximum value	Average value	Standard deviation	
COD	0.410	0.068	0.056	✓
TN	5.701	0.767	0.681	✓
TP	0.497	0.074	0.066	✓

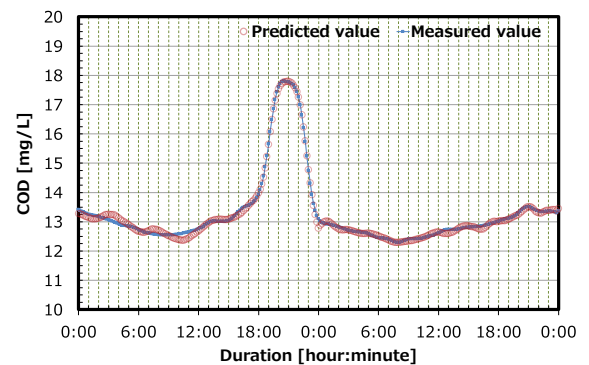

(a) Graph of evaluation data (COD)

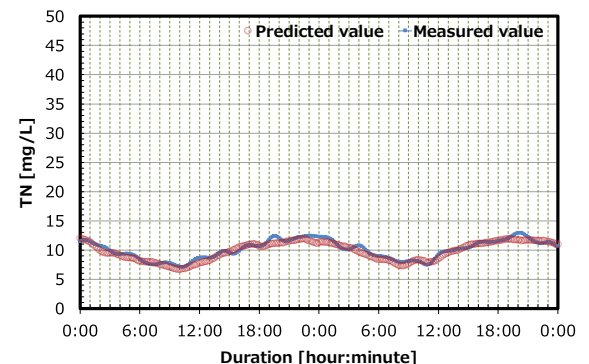

(b) Graph of evaluation data (TN)

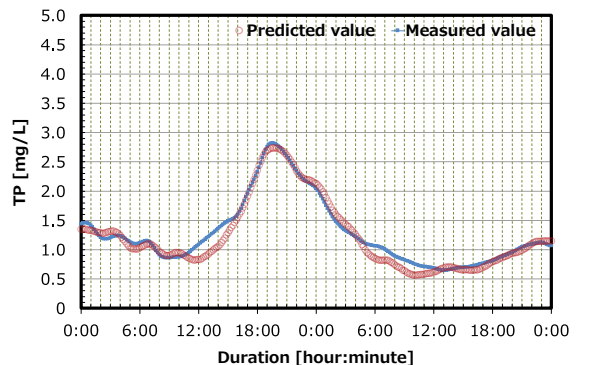

(c) Graph of evaluation data (TP)

Fig. 7. Graph of evaluation data

graphs of the 48-hour (2,880-minute) data extracted from the evaluation data.

As shown in Table 3, we were able to create a learning model in which the maximum values of error $E(t)$ in all discharged water quality parameters satisfied the judgment criteria. As shown in Fig. 7 (a) through Fig. 7 (c), even when the predicted values $P(t)$ changed significantly, they were able to be followed by the measured values $M(t)$, which proves that the created learning model can accurately predict the measured values after $W (= 120)$ minutes.

4-4 Results of evaluation based on real-time data

Using the learning model that was evaluated in the previous section, we conducted an evaluation test based on actual measurement data over four non-consecutive days at the sample treatment plant. We inputted real-time measurement data stored on the monitoring and control equipment into the learning model after removing noise by applying the LPF at intervals of 10 minutes, and we predicted the discharged water quality two hours later. The test results are shown in Table 4, and selected graphs of the test results are shown in Fig. 8 (a) through Fig. 8 (c). Since the judgment criteria were satisfied on all the test days, it was confirmed that the created learning model had high prediction accuracy.

Table 4. Test results based on real-time data

Date of testing		Day 1	Day 2	Day 3	Day 4			
Weather		Clear	Cloudy	Cloudy	Rainy			
Rainfall(mm/day)		0.0	0.0	0.0	184.2			
Maximum temperature(°C)		9.0	12.0	10.2	9.5			
Minimum temperature(°C)		-2.9	6.4	1.9	4.5			
		Judgment criteria	Test results				Calculated value	
COD (mg/L)	Overall error	Average value	-	0.5	0.4	0.4	0.3	0.4
		Maximum value	-	1.0	0.9	0.8	0.8	1.0
	2-hour average	Average value	-	0.5	0.4	0.3	0.4	0.4
		Maximum value	2.0 max.	0.6	0.5	0.5	0.5	0.6
TN (mg/L)	Overall error	Average value	-	1.5	1.2	1.7	0.6	1.2
		Maximum value	-	3.2	2.2	2.8	1.8	3.2
	2-hour average	Average value	-	1.4	1.0	1.5	0.6	1.1
		Maximum value	10.0 max.	2.6	1.9	2.2	0.7	2.6
TP (mg/L)	Overall error	Average value	-	0.15	0.26	0.09	0.10	0.15
		Maximum value	-	0.28	0.33	0.17	0.20	0.33
	2-hour average	Average value	-	0.15	0.26	0.10	0.08	0.15
		Maximum value	1.00 max.	0.25	0.30	0.14	0.11	0.30

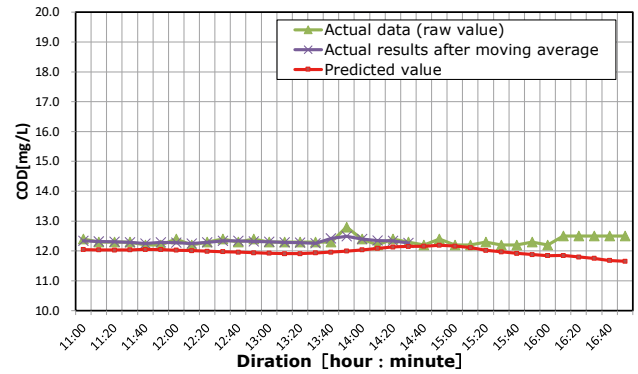

(a) Graph of test results (COD)

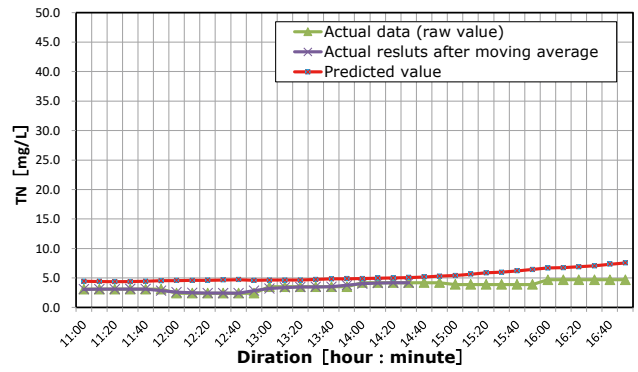

(b) Graph of test results (TN)

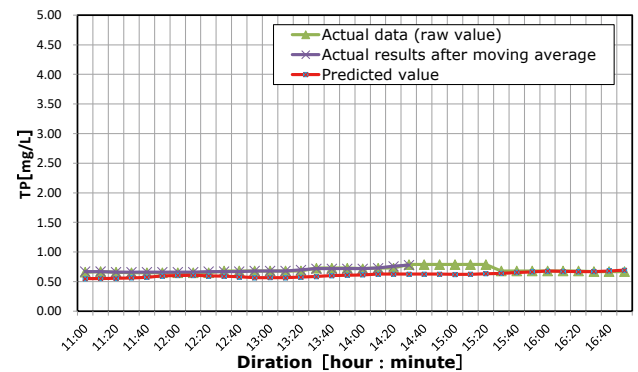

(c) Graph of test results (TP)

Fig. 8. Graph of test results

5. Conclusion

We have developed a technology for predicting COD, TN and TP in discharged water at sewage treatment plants using AI. This technology can be applied to a wide variety of sewage treatment plants because it can predict the discharged water quality using general-purpose sensors regardless of the treatment method.

In the future, we plan to promote the introduction of this technology to improve the efficiency of maintenance and management of sewage treatment plants and to further expand the scope of application of AI-based prediction.

Contributors The lead author is indicated by an asterisk (*).

A. OKUBO*

• Group Manager, Nissin Electric Co.,Ltd



T. TAKEHARA

• Manager, Nissin Electric Co.,Ltd



L. HUANG

• Nissin Electric Co.,Ltd

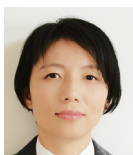

M. MORIMOTO

• Ph.D
Nissin Electric Co.,Ltd



K. KASUYA

• Manager, Nissin Electric Co.,Ltd



Source of reference

A. Okubo, et al., "AI-based Prediction of Quality of Water Discharged from Sewage Treatment Plant," The Nissn Electric Review, vol. 66, No.1 (Serial No.155), pp28-32 (June 2021)