

Environmental Initiatives

- Toward the Realization of a Carbon-Free Society -

Sumitomo Electric Industries, Ltd.

May 25, 2021

(Several pictures were replaced on Sep 10, 2021)

Table of contents

I. Corporate philosophy and value to provide **P 3**

II. Toward the realization of a carbon-free society

-1. Contribution from business activities **P 7**

-2. CO₂ reduction targets and internal activities **P19**

III. Other environmental initiatives **P24**

I. Corporate philosophy and value to provide

Corporate philosophy and management resources that support value creation

Based on the Sumitomo Spirit and the Sumitomo Electric Group Corporate Principles, we will conduct our business activities with our unchanging basic policy of always harmonizing with the public interest and contributing to society.

Business resources

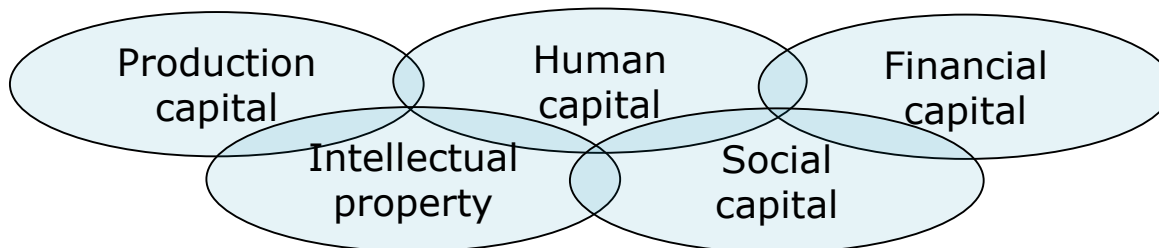

Corporate philosophy

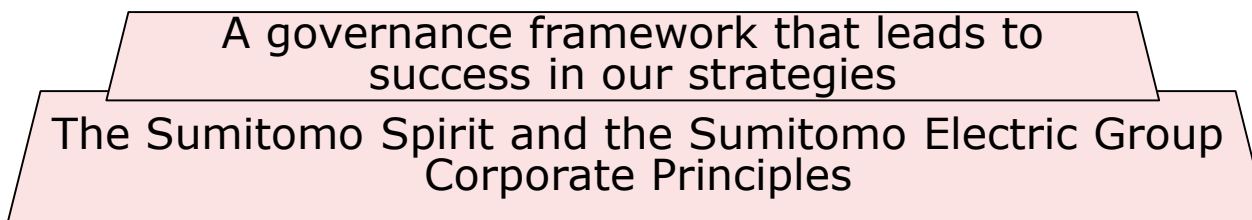

The Sumitomo Electric Group Corporate Principles

- Each company of the Sumitomo Electric Group shall
- Offer the very best goods and services to satisfy customer needs.
 - Build technical expertise, realize changes and strive for consistent growth.
 - Contribute to creating a better society and environment, with a firm awareness of our social responsibility.
 - Maintain high corporate ethics and strive to become a company worthy of society's trust.
 - Nurture a lively corporate culture that enables employee self-improvement.

Focused social issues and the value we provide

We will solve the focused social issues by providing the value created by Sumitomo Electric.

Values the Sumitomo Electric Group offers

Social issues we need to focus on

- ✓ Worsening global warming
- ✓ Depletion of resources
- ✓ Increasingly frequent and severe disasters
- ✓ Disrepair and aging of social infrastructure
- ✓ A need for smoother road transport
- ✓ Increasing importance of open innovation

A healthier planet for future generations



Development of eco-friendly products that limit CO₂ emissions



Encouraging use of renewable energy with smart energy systems



Promoting recycling technologies and pursuing materials development less dependent on scarce resources, driving resource-friendly practices

Communities where everyone is safe



Car-to-car and car-to-road connectivity for a safer driverless society



Creating a secure urban environment with enhanced infrastructure durability



Increasing telecommunications security for safety and privacy

A comfortable, growing society



Achieving faster data transmission through advanced infocommunication technologies underpinning an IoT-based society



Providing technology that connects automobiles to society, liberating transportation and increasing comfort



Developing solutions that connect cars, houses, people, and communities, enabling effective energy-sharing

Today, we will explain mainly the themes related to **decarbonization**.

Group's business and priority fields

Five business fields

Based on our founding business of copper smelting and the accumulated technology from the manufacture of electric wires and cables, we have developed five business fields.

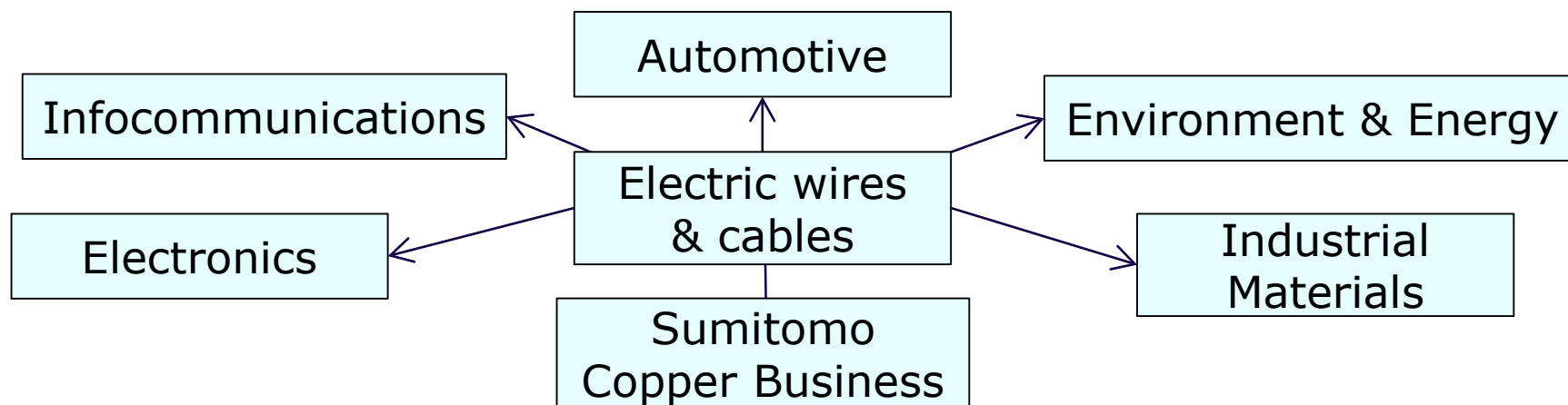

Three priority fields (Mobility, Energy, and Communications)

MO Mobility: CASE* will allow the mobility field to provide new value to society.

E Energy: Eco-friendly energy will bring about more sustainable societies.

CO Communications: We will live in a smart society where everything is connected by a network.

II. Toward the realization of a carbon-free society

-1. Contribution from business activities

Business contribution in the fields of Mobility, Energy, and Communications

MO Mobility

Contribution to the electrification and weight reduction of automobiles

High-voltage harness



Aluminum harness



Rectangular magnet wires for motors in electric vehicles

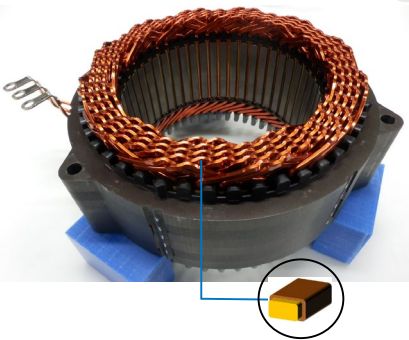

Charging connector for EVs



E Energy

Contribution to renewable energy and the development of infrastructure

Redox-flow battery for solar panels



Offshore wind power generation



CO Communications

Contribution to the realization of a data-driven society

Low power consumption of data centers

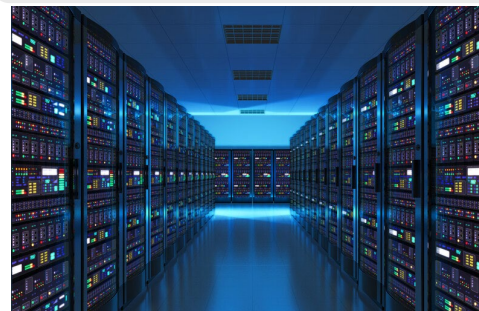

GaN device for mobile phone base stations (power saving)

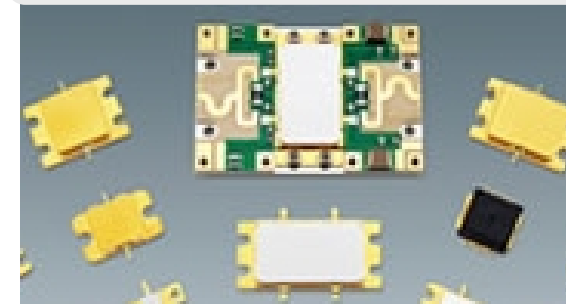

In the fields of Mobility, Energy, and Communications, we have a lot of product families that contribute to the realization of a carbon-free society.

Contribution in the energy business field

Realization of a carbon-free society

Green recovery policy

Establishment of CO₂ reduction targets in each country

Expansion of the renewable energy ratio

Introduction of energy-saving technologies

Challenge (1): Full-scale introduction of onshore and offshore wind power generation

Challenge (2): Geographical distance from power generation areas to demand areas

Challenge (3): Unstable power generation depending on natural conditions

Wind power generation

Interconnection

Storage battery

Energy management system (EMS)

Today, we will explain each of the businesses of wind power generation, interconnection, redox-flow battery, and energy management system.

Corporate philosophy and value to provide

Business contribution to decarbonization

Internal activities for decarbonization

Other initiatives

Energy: Onshore and offshore power generation

Market trends

- Expansion and acceleration of investment through green recovery policy
- Larger wind turbines, large-scale offshore wind farms, and the expansion of installation areas (coast → seabed-mounted offshore, floating offshore)

Our strengths

- Excellent technical capability
 - Capability to develop products that meet market needs
 - Japan's largest construction capacity
- Group synergies with Nissin Electric and Sumitomo Densetsu

Collaboration solution with Nissin Electric and Sumitomo Densetsu

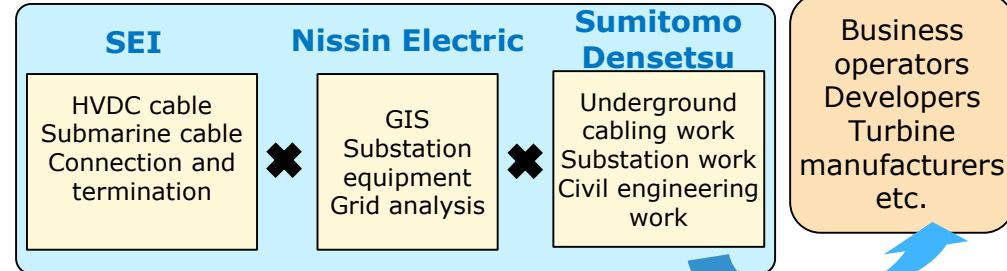

[World market for offshore wind power]

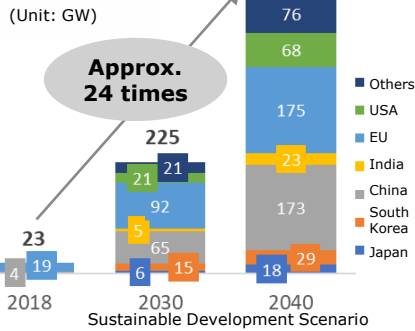

[Larger wind turbines]

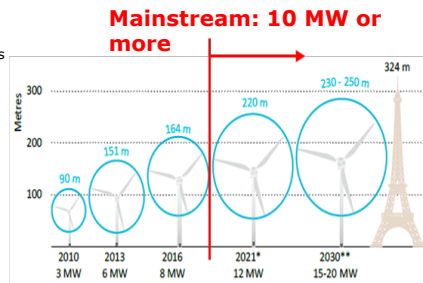

<Collaboration example: Wind Farm Tsugaru>

- Construction of long-distance power transmission lines for one of the largest onshore wind farms in Japan
- Cable length: 34 km (underground power transmission)
- Completion in May 2020

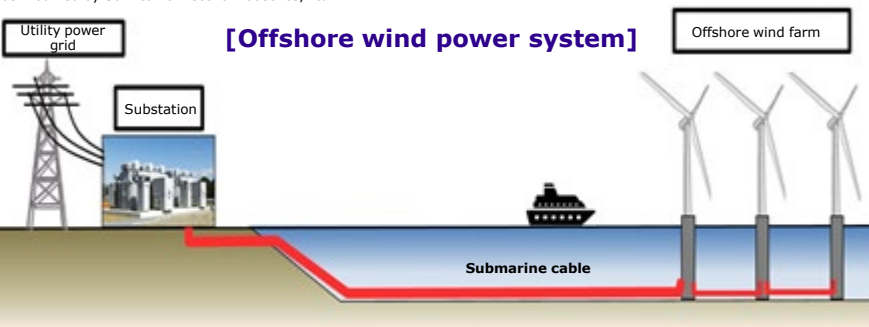
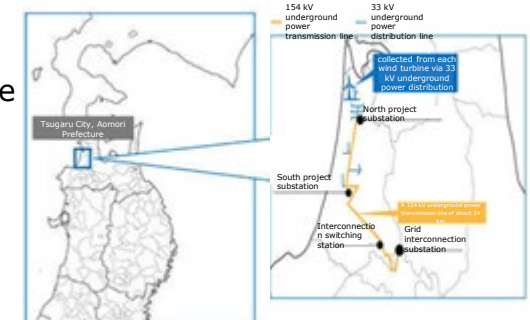

Energy: Interconnection

Market trends

- Construction of interconnection is increasing to strengthen the power grid system and expand the use of renewable energy.
- High-voltage, long-distance transmissions are accelerating.

[Demand for HVDC cables in Europe]



Land and submarine: 13,000 km

[Grid enhancement plan in Japan]

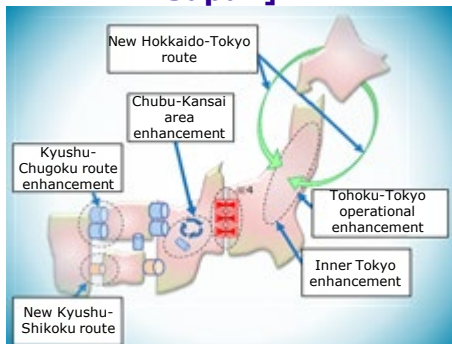

Source: OCCTO, Power Supply Uneven Distribution Scenario

Our strengths

Excellent technical capability

- Capability to develop ultra-high voltage DC cable with high insulation performance (compound)



Extensive track records for HVDC projects

- Japan: Hokkaido-Honshu interconnection
- Overseas: UK-Belgium submarine cable and others

Collaboration with partners

- Packaged solution in cooperation with Siemens Energy, Germany, and others

Expanding sales of power cable business

- Increasing demand for renewable energy at home and abroad
- Accelerated grid enhancement

⇒ We aim to expand sales of the power cable business

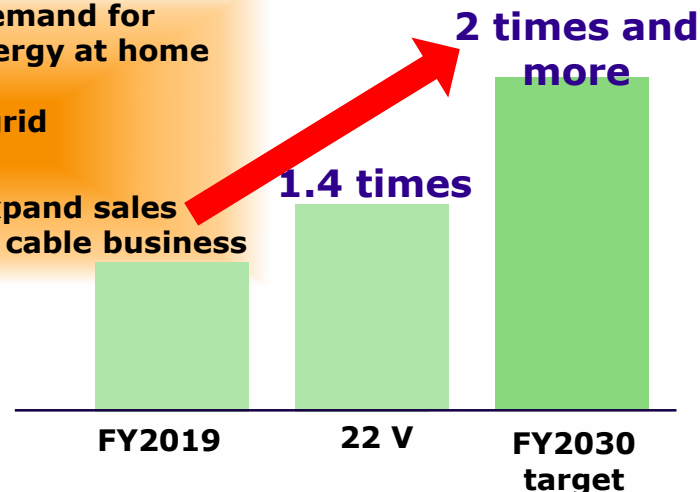

<We won orders for 525 kV DC XLPE land cables for Corridor A in Germany.>

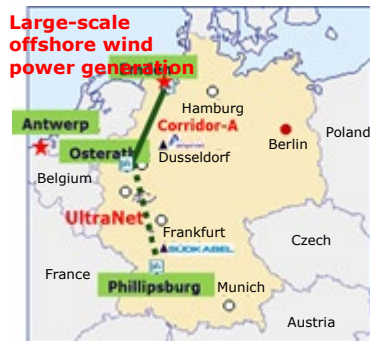

<Corridor A overview>

Project to enhance the power grid system that connects offshore wind power off the North Sea and southern demand areas.

- Our track records in European projects and original insulation technology to result in winning the orders in May 2020.
- Cable length: 640 km (the world-first 525 kV DC XLPE cable)
- Completion in 2029

Energy: Redox-flow (RF) battery

RF battery features: Fire safety, long life, and high reliability

Storage battery market forecast (worldwide/cumulative)

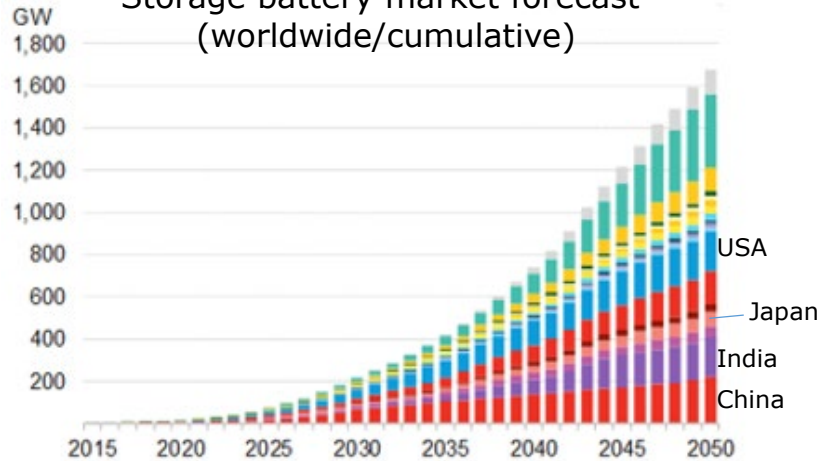

Source: BNEF Long-Term Energy Storage Outlook 2020

Storage batteries are essential for carbon neutrality; long-term market expansion is expected.

Hokkaido Electric Power Network, Inc. (under construction)

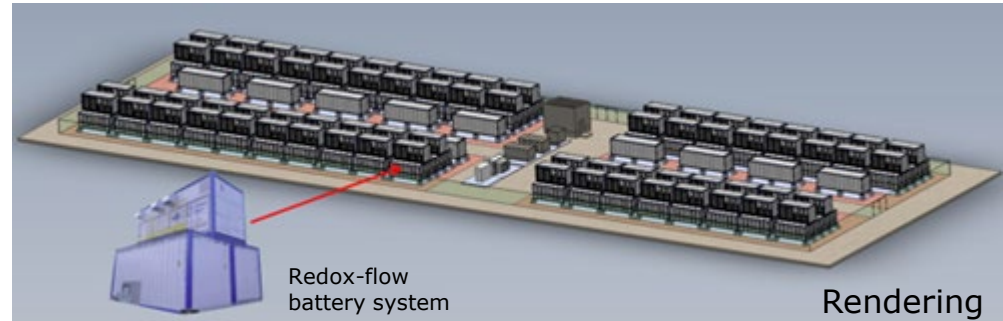

Facilities: 51,000 kWh (17,000 kW x 3 hours)
 Purpose: New interconnection of wind power
 Expected completion: March 2022

The new design reduces the footprint by 30% compared to the conventional model.

Maeda Corporation



750 kWh
 Completion in 2018

Shalun Smart Green Energy Science City in Taiwan



750 kWh
 Completion in 2020

San Diego Gas & Electric in USA



NEDO demonstration: 8,000 kWh
 Completion in 2017
 Supporting micro grid in 2021



Hokkaido Electric Power Network, Inc.
 • 60,000 kWh, completion in 2015
 • Proven high safety and earthquake resistance (2018 Hokkaido Eastern Iburi earthquake)

Energy: Energy management system (EMS)

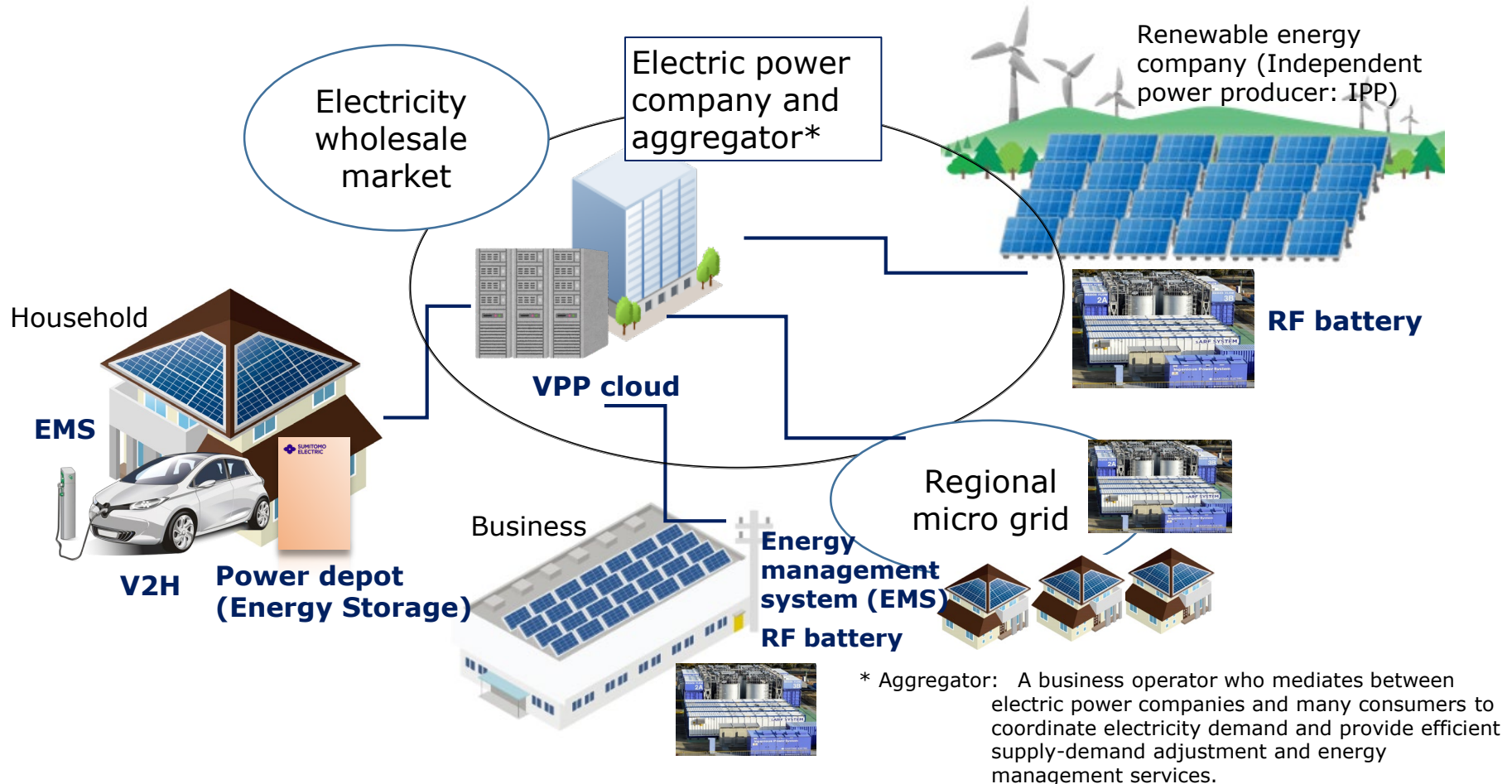

By using the high-speed, large-scale, and highly reliable communication control technology cultivated through our business with telecommunications carriers, we predict power generation and demand patterns with high accuracy and optimally control supply and demand.

Contribution in the mobility business field

Business structure vision in the CASE era

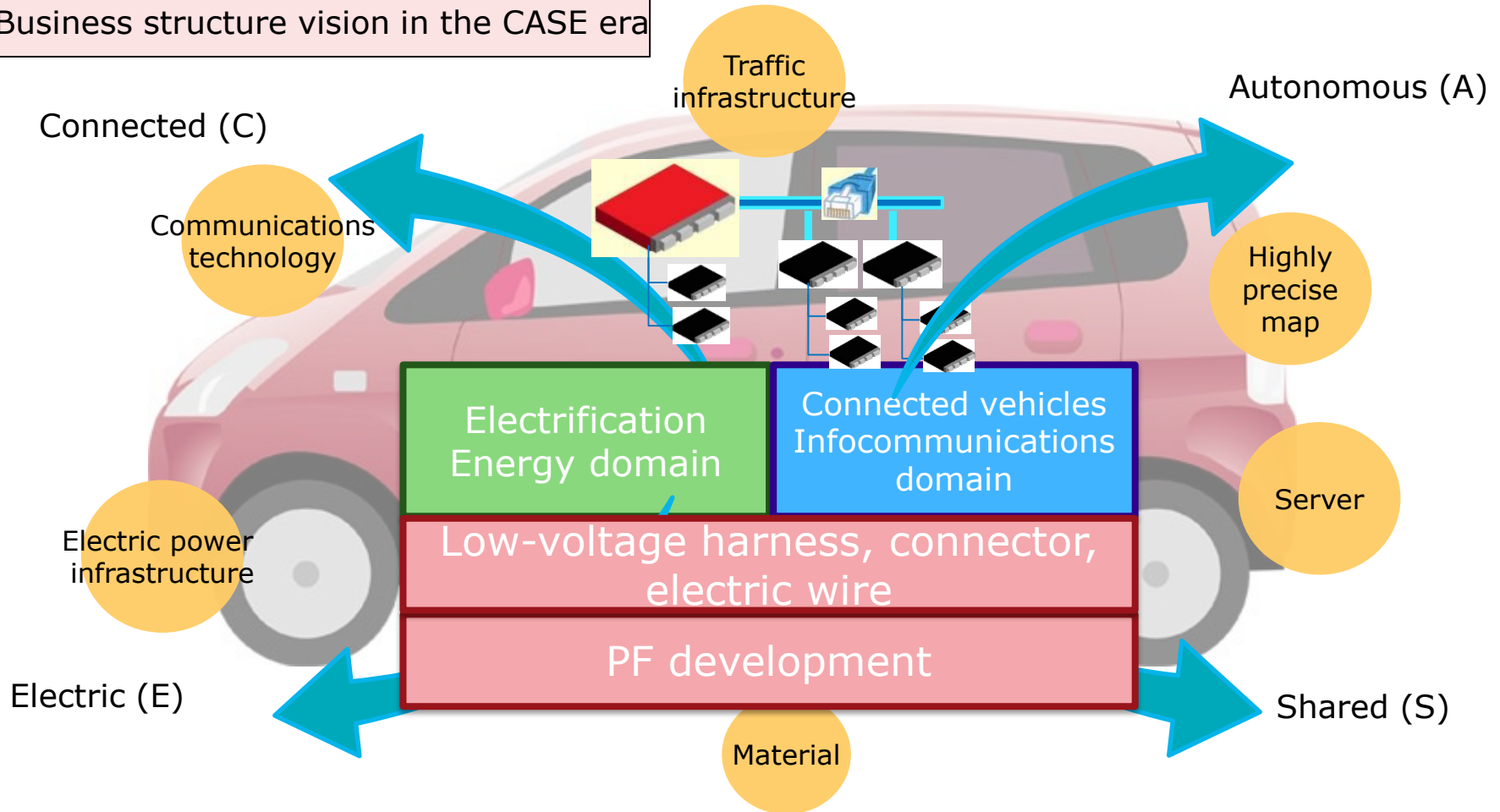

We will expand business in the electrification-energy domain and the connected vehicles- infocommunications domain.

Mobility: Various product families in the CASE era

Electrification



Charging connector

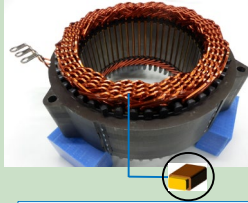

Motor magnet wire

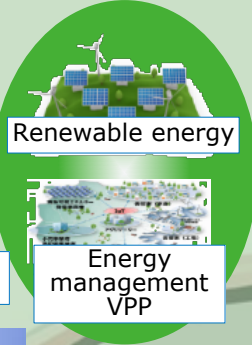

Renewable energy

Energy management VPP



Busbar module



High-voltage junction block (JB)



Pipe harness



Power cable

Connected vehicles



Traffic infrastructure control

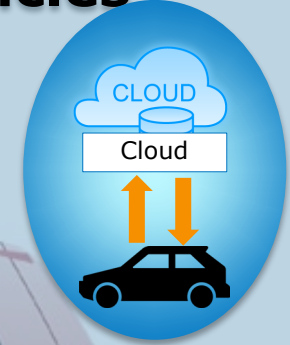

Central gateway



High-speed communications harness

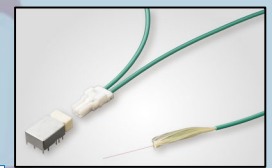

Optical harness

Low-voltage harness, connector, electric wire

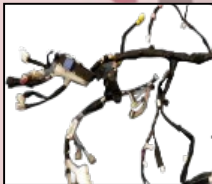

Low-voltage harness



Aluminum harness

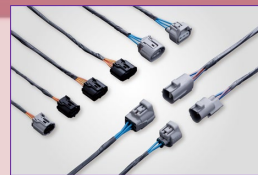

Connector

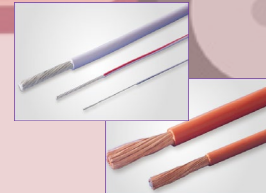

Electric wire

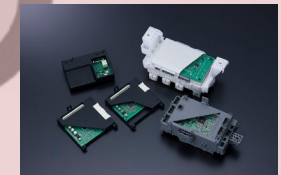

Electronics product

Mobility: Progress of xEV and demand for wiring harnesses

* xEV: A collective name for electric vehicles, including BEVs, HEVs, PHEVs, and FCVs.

World automobile production forecast (unit: 10,000)

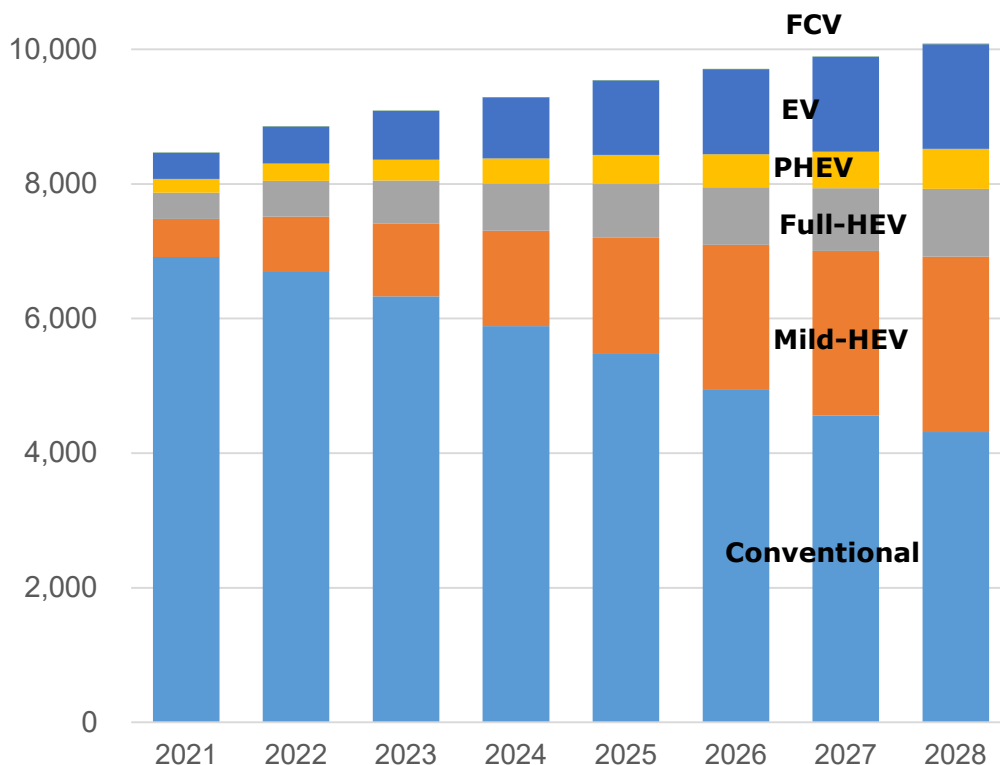

* Source: IHS Markit February 23, 2021

Number of wiring harness (WH) circuits
(Where the number of circuits for a medium-sized gasoline vehicle is taken as a benchmark of 100)

		Gas	HEV	P-HEV	EV
Low voltage	For engine	15	15	15	0
	For instrument panel and others	85	98	98	95
High voltage		0	1	2	2
Around a battery		0	10	11	19
Total		100	123	126	116
Change factor			High-voltage circuit Around a battery (small)	High-voltage circuit Around a battery (small) Charging circuit	Reduced engine WH High-voltage circuit Around a battery (large) Charging circuit

* Source: Our estimate

The shift to xEVs increases the number of wiring harnesses for high-voltage purpose and around a battery. (EVs do not require a wiring harness for an engine.) ⇒ Overall, the number of circuits increases, particularly due to the increasing demand for wiring harnesses around a battery.

Mobility: Movement for ECU integration

Changes to architecture

Current

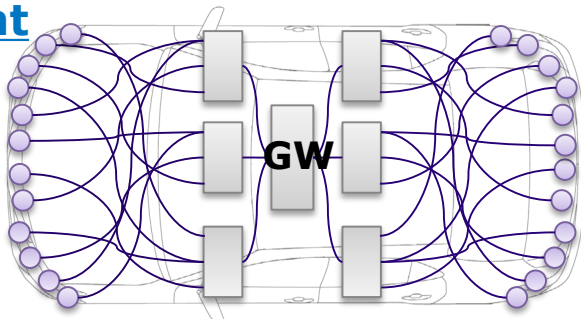

Individual wiring from each ECU to devices

Future

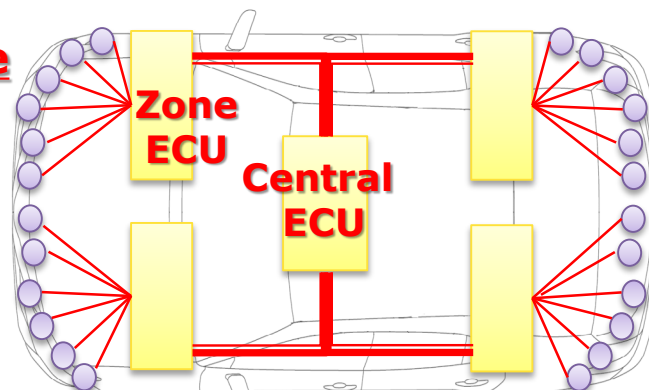

The central ECU and the zone ECUs are connected via trunk lines; each device is connected from the zone ECU (i.e., reduction in the number of circuits)

Changes in the number of circuits

*Where the number of circuits for a car today is taken as a benchmark of 100

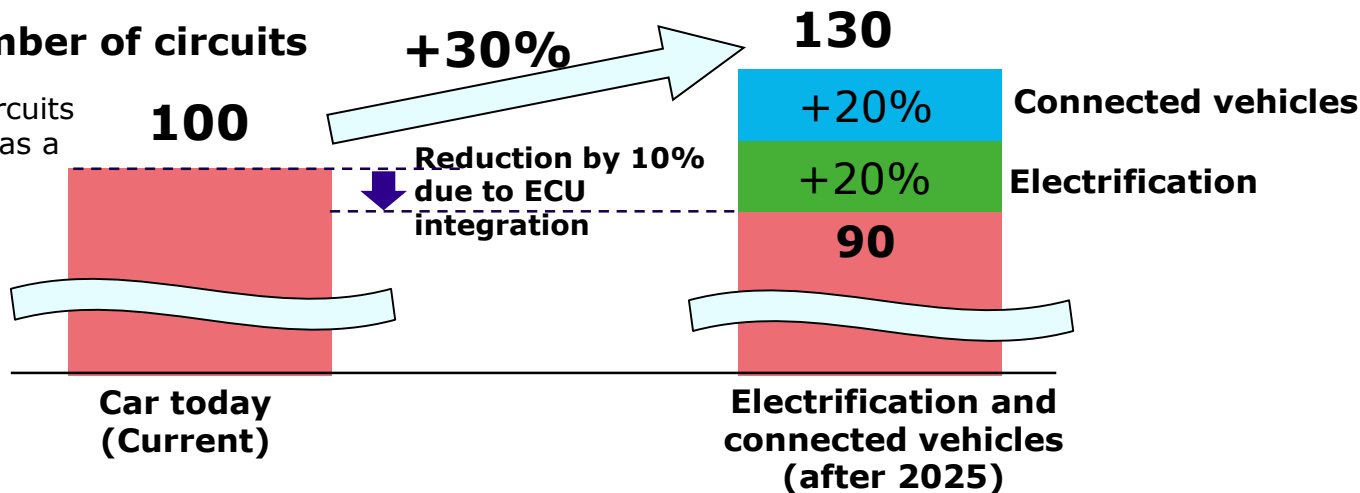

The number of circuits will partly decrease due to ECU integration but increase in total due to electrification and connected vehicles.

II. Toward the realization of a carbon-free society

-2. CO₂ reduction targets and internal activities

CO₂ reduction targets

FY2030

Achievement of the reduction of CO₂ emissions at the level required by the Paris Agreement

(Internal reduction: 30%; external reduction: 15%, compared to FY2018)

FY2050

Realization of carbon neutrality

Achievement of virtually zero CO₂ emissions



SCIENCE
BASED
TARGETS

DRIVING AMBITIOUS CORPORATE CLIMATE ACTION

In April 2021, SBT certification was obtained for the reduction targets in 2030

Reduction of CO₂ generated from our in-house manufacturing (Scopes 1 and 2)

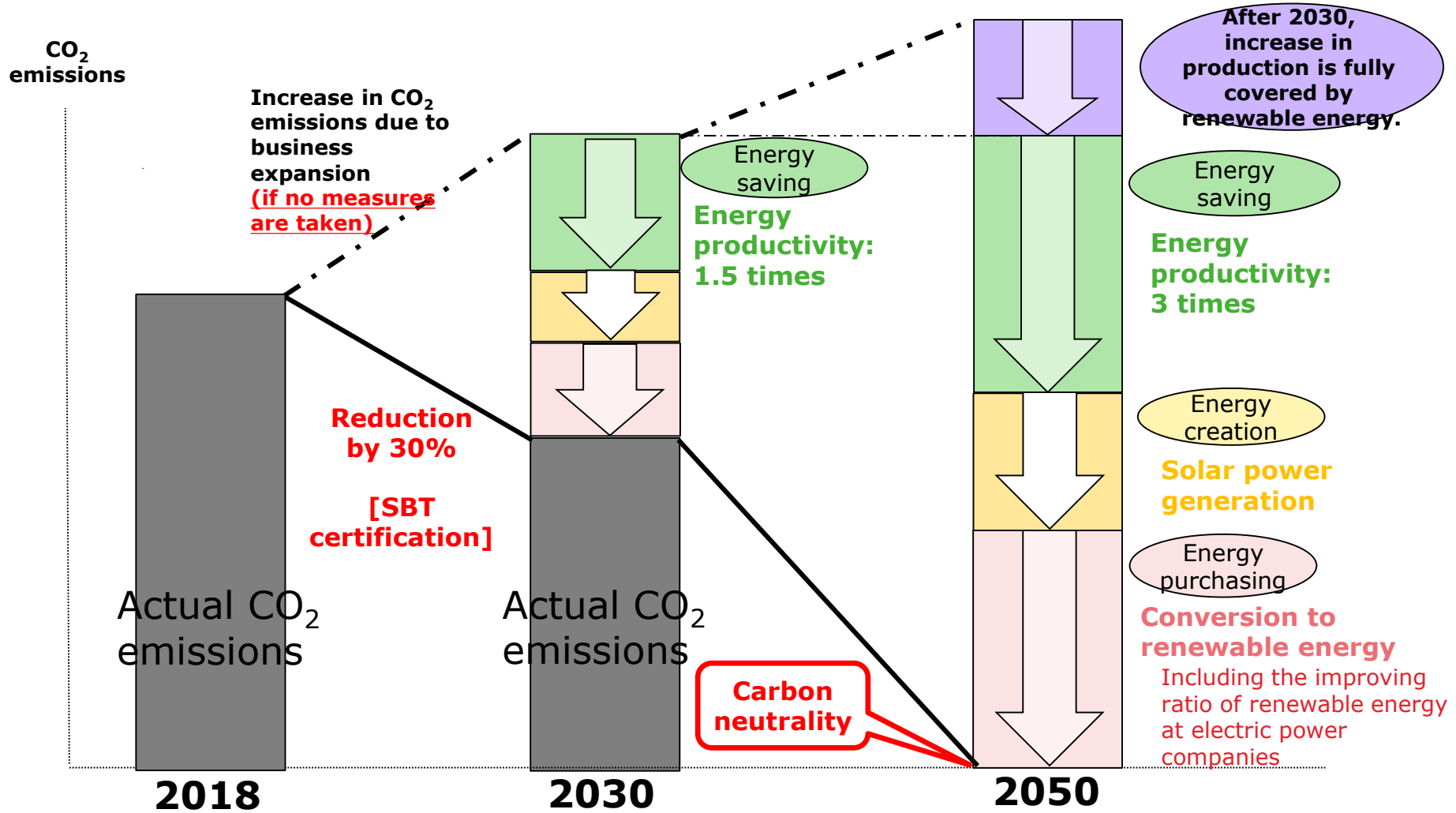

We will reduce CO₂ emissions by combining

Energy saving

Energy creation

Energy purchasing

Examples of energy-saving technical measures: Effective use of thermal energy

■ Increased productivity

- Loss reduction (reduced equipment failure and improved yield) and process development (process consolidation, omission, and electrification)

■ Highly efficient heating and curing technologies (low CO₂)

- Use of IH, UV-LED, and laser, **improved heating process efficiency**, and non-use of LNG (H₂NH₃ mixed combustion and methanation)

■ Heat exchange and exhaust heat recovery technologies

- **Multi-stage exhaust heat recovery** and low temperature recovery (binary power generation)

■ Optimized energy saving and effective use of heat at the entire factory

- Constant monitoring and optimal control by using IoT/AI, optimization and high efficiency of equipment use, and clean room stratified air conditioning

Example of improved efficiency in heat treatment process

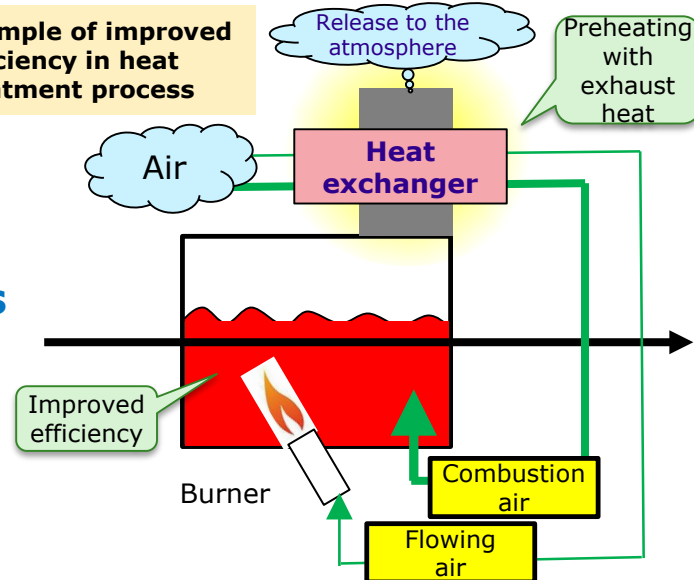

Example of minimized loss in heat treatment process

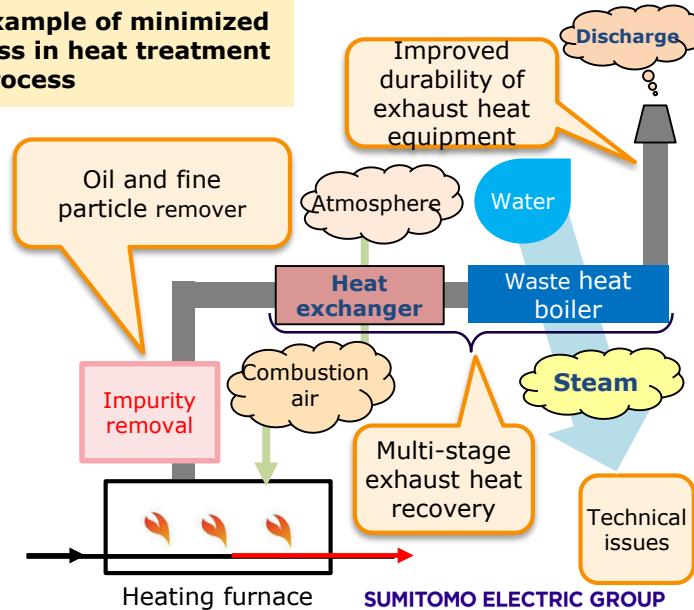

Specific examples of energy creation and purchasing: Net-zero emission factory

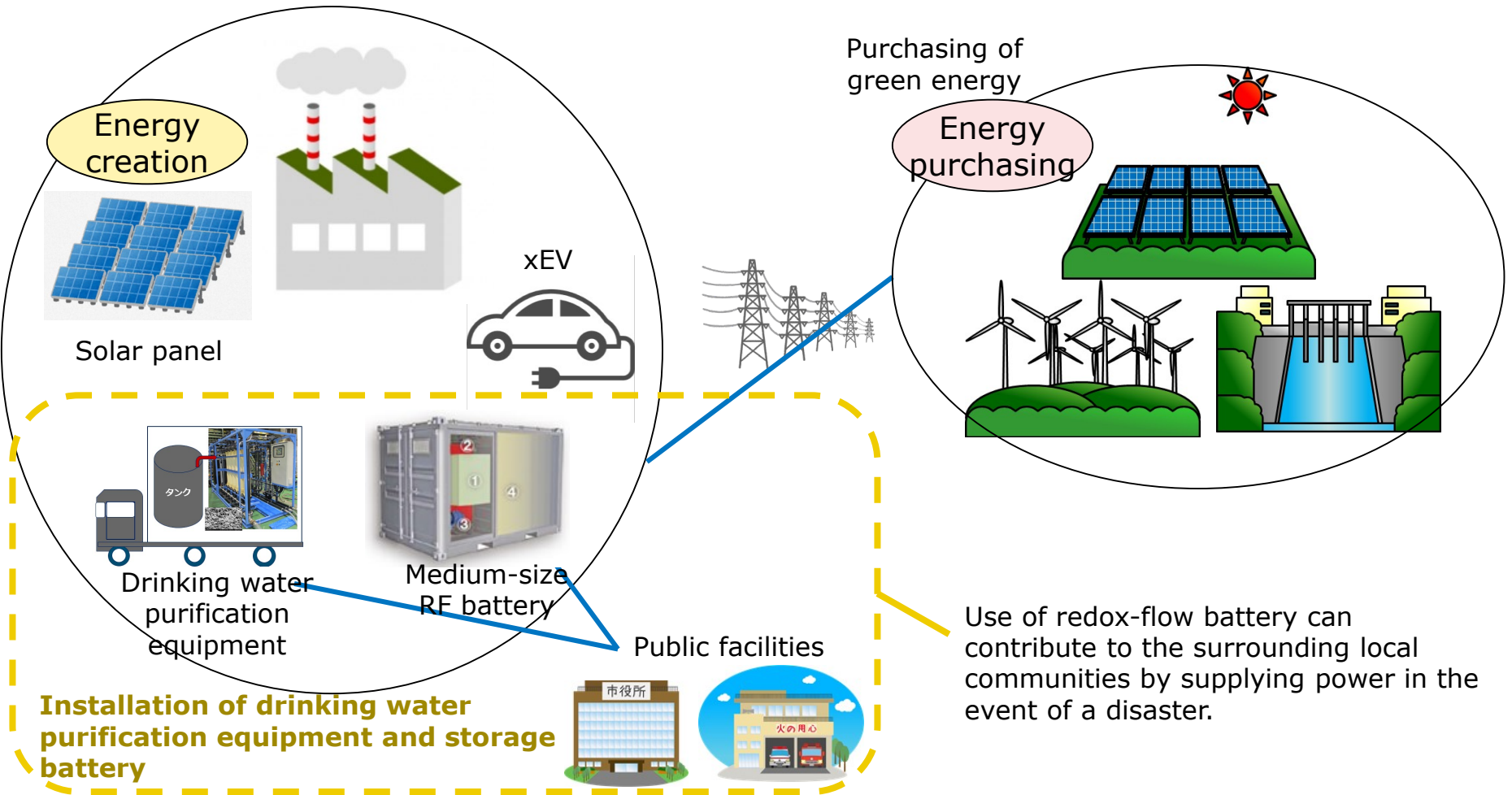

We will realize net-zero emissions by combining in-house power generation (energy creation), including solar power, and purchasing of renewable energy (energy purchasing).

III. Other environmental initiatives

Environmental activities other than decarbonization

Promotion of resource saving and recycling

- ✓ Reduction of waste amount per unit by 5% compared to FY2017
- ✓ Reduced water consumption per unit by 5% compared to FY2017 (FY2022 target)

Reduction of environmentally hazardous substances

- ✓ Reduction of emissions of PRTR-designated substances by 5% compared to FY2017 (FY2022 target)

Conservation of biodiversity

- ✓ Promotion of joint activities with the local communities (community cleaning, tree planting, and protection of native organisms)

Water treatment business

Water treatment using our proprietary microfiltration membrane, Poreflon module

Product features

- Contamination resistance
- High durability and long life
- Energy and space saving

Stable operation at more than 700 sites across the world

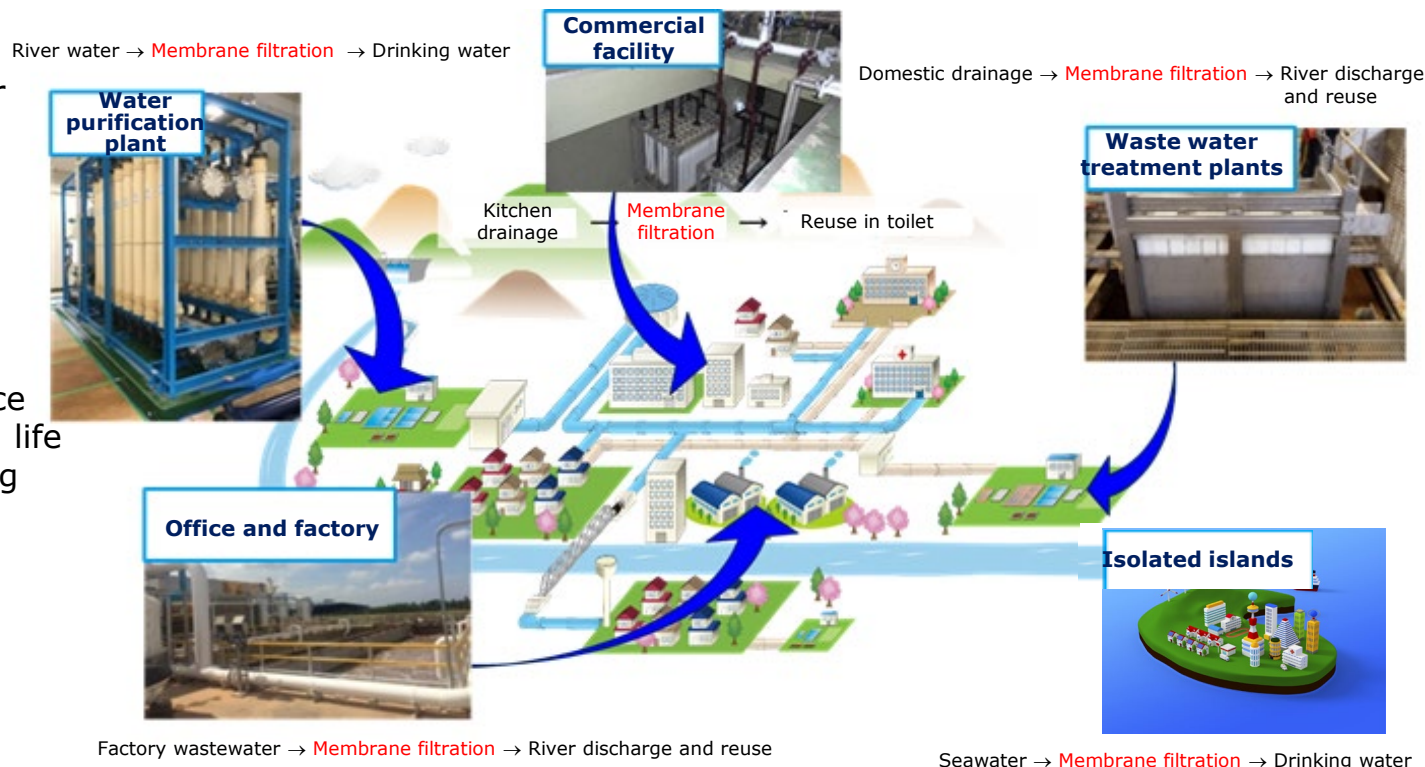

Corporate philosophy and value to provide

Business contribution to decarbonization

Internal activities for decarbonization

Other initiatives

Sustainability management system

In January 2021, we established the Sustainability Management Promotion Committee under the direct control of the president to further strengthen sustainability management, including environmental issues.

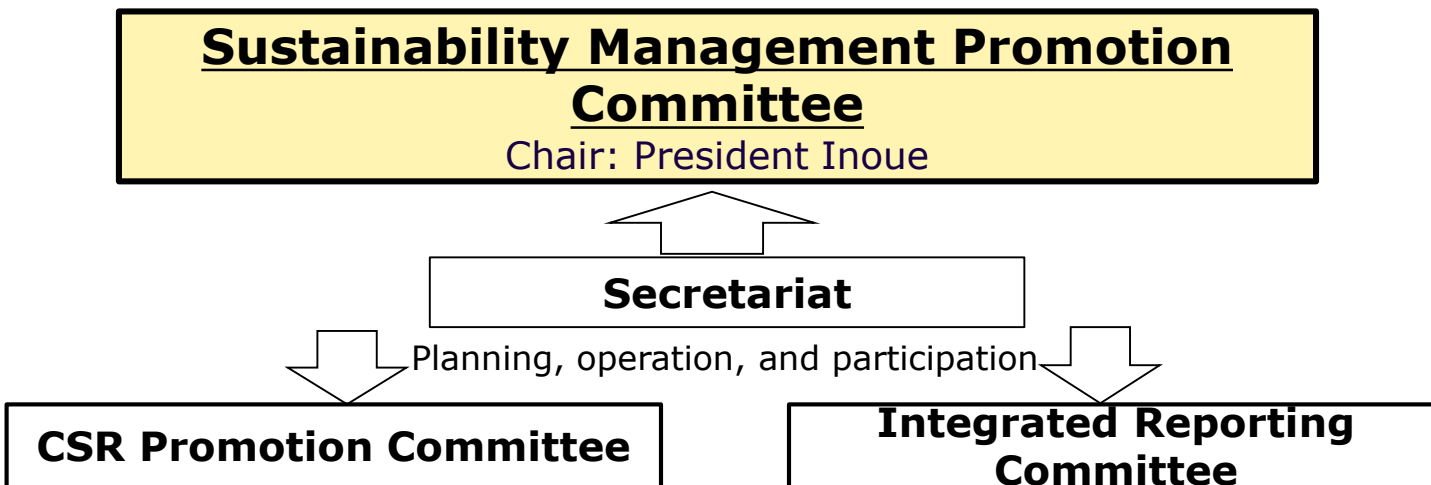

TCFD support

To further strengthen our environmental initiatives, we have expressed our support for TCFD and will promote information disclosure according to the TCFD framework.

Governance

Strategy

Risk management

Metrics and targets

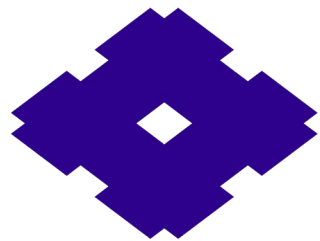

**SUMITOMO
ELECTRIC**

Connect with Innovation

<https://sumitomoelectric.com/>

**SUMITOMO
ELECTRIC
GROUP**